



Department of Empowerment of Persons with Disabilities (Divyangjan)
Ministry of Social Justice & Empowerment



सत्यमेव जयते
GOVERNMENT OF INDIA
MINISTRY OF SKILL DEVELOPMENT
& ENTREPRENEURSHIP



Facilitator Guide



Sector
Apparel / Made-Up's /
Home Furnishing

Sub-Sector
Apparel / Made-Up's /
Home Furnishing

Occupation
Stitching

Reference ID: AMH/Q0301, Version 1.0
Reference ID: PWD/AMH/Q0301, Version 1.0
NSQF level: 4

Sewing Machine Operator

for Locomotor Disability
for Speech and Hearing Impairment

Published by



RACHNA SAGAR PVT. LTD.

4583/15, Daryaganj, New Delhi, 110002, PO Box 7226

Phone: 011 - 4358 5858, 2328 5568 Fax 011 - 2324 3519, 4311 5858

Email: info@rachnasagar.in

All Rights Reserved,
First Edition, March 2016
ISBN 978-1-111-22222-45-7
Printed in India

Copyright © 2017



Apparel Made-ups & Home Furnishing Sector Skill Council

Indian Buildings Congress, 1st Floor, Sector-6, R K Puram

Kama Koti marg, New Delhi - 110022

E-mail : info@sscammh.com

Website : www.sscammh.com

Disclaimer

The information contained herein has been obtained from sources reliable to AMHSSC. AMHSSC disclaims all warranties to the accuracy, completeness or adequacy of such information. AMHSSC shall have no liability for errors, omissions, or inadequacies, in the information contained herein, or for interpretations thereof. Every effort has been made to trace the owners of the copyright material included in the book. The publishers would be grateful for any omissions brought to their notice for acknowledgements in future editions of the book. No entity in AMHSSC Council shall be responsible for any loss whatsoever, sustained by any person who relies on this material. The material in this publication is copyrighted. No parts of this publication may be reproduced, stored or distributed in any form or by any means either on paper or electronic media, unless authorized by the AMHSSC.

Note: SCPwD

SCPwD has borrowed the qualification of Sewing Machine Operator from Apparel SSC which is approved by NCVET in the 18th meeting of NSQC on 28th April 2022 (Link of MOM https://nqr.gov.in/sites/default/files/Q%20file%20Retail%20Trainee%20Associate_LV.pdf And uploaded on NQR WWW.nqr.gov.in The book caters to the job role aligned to the following disabilities as per the NQR codes mentioned below.
For LD- 2022/PWD/SCPWD/05827
For SHI- 2022/PWD/SCPWD/05828





Shri Narendra Modi
Prime Minister of India

“ Skilling is building a better India.
If we have to move India towards
development then Skill Development
should be our mission. ”

Acknowledgement

We are thankful to Talento Pvt. Ltd. and all other organisations who have helped us in preparing this Facilitator Guide.

We are especially thankful to Dr. S.K Sharma (M/S The Assessors Guild) for their unequivocal support in the entire process.

We are also thankful to M/S Poppys Knitwears Private Limited, M/S Kanhaiyalal Kalyanmal, M/S Nirvana, M/S Poddar International, M/S Paper Moon, M/S Ocean Exim India Pvt. Ltd. and Savvy Corporation for their kind support in development of this guide.

About this Guide

This Facilitator Guide is designed to enable training for the **Quality Pack (QP)**. Each National Occupational Standard is covered across Unit/s.

The Trainers will be able to get a clear insight regarding the purpose of the program and will be able to give the trainees proper training regarding searching or sewing fabrics, fur and synthetic materials.

The various requirements of team working, detecting quality defects, maintaining healthy workplace and so on can be provided by the trainers themselves.

The rules and regulations for providing the training have been clearly given in the book and they should be holistically followed by the trainers to meet the purpose behind the framing of this course.

Key features for that NOS.

- Carry out sewing by hand.
- Contribute to achieve product quality in searching operation.
- The trainees will be able to search/sew fabrics.
- The trainees will be able to search/sew fur.
- The trainees will be able to search/sew synthetic materials.
- The trainees are able to accurately work with the sewing machines and are able to perform hand works, operate and work accordingly to increase productivity.
- The trainees are able to identify quality defects and can perform improvements to avoid defects.
- The trainees are able to maintain a clean and healthy working environment.
- The trainees are able to understand the rules and regulations related to apparels in a country.

The symbols used in this book are described below.

Symbols Used

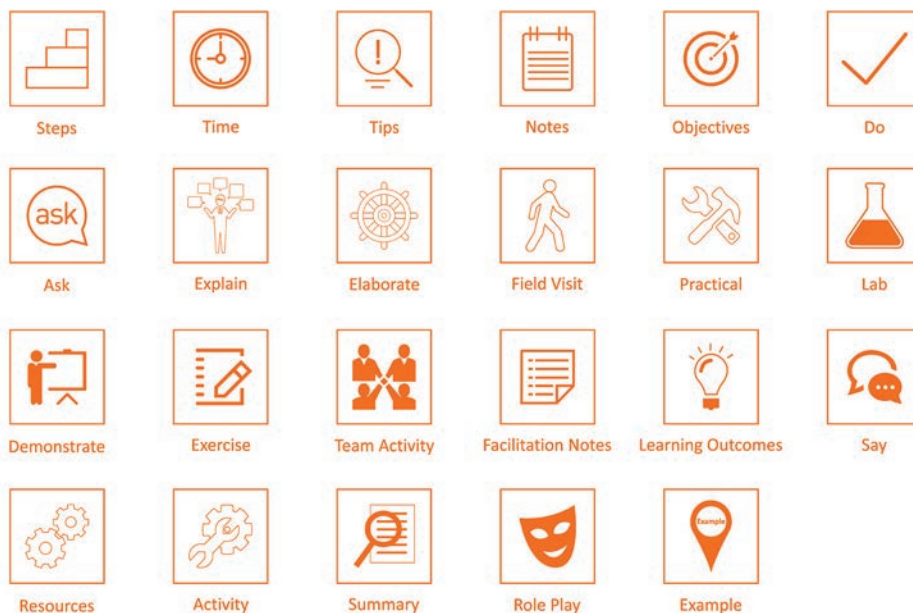

Table of Content

S. No.	Modules and Units	Page No.
1.		1
		3
		7
2.		9
		11
		14
		27
		44
3.		69
		71
4.	Maintain Work-Area, Tools and Machines (AMH/N0102)	73
	Unit 4.1 - Maintain Work Area, Tools and Machines	75
5.	Maintaining Health, Safety and Security at Workplace (AMH/N0103)	81
	Unit 5.1 - Maintaining Health, Safety and Security at Workplace	83
6.	Comply with Industry, Regulatory and Organizational Requirements (AMH/N0104)	89
	Unit 6.1 - Comply with Industry, Regulator	91
7.	Professional Skills	99
	Unit 7.1 Professional Skills	101
8.	IT Skills	103
		105
	Unit 8.2 - Basic Computer Knowledge	107
	Unit 8.3 - Components of Computer	109
		111
	Unit 8.5 - MS Word	114
	Unit 8.6 - MS PowerPoint	116
	Unit 8.7 - MS Excel	118
	Unit 8.8 - Internet Concepts	120
9.	Employability & Entrepreneurship Skills	123
	Unit 9.1 – Personal Strengths & Value Systems	126
	Unit 9.2 – Digital Literacy: A Recap	155
		163
	Unit 9.4 – Preparing for Employment & Self Employment	179
	Unit 9.5 – Understanding Entrepreneurship	194
	Unit 9.6 – Preparing to be an Entrepreneur	216





Skill India
कौशल भारत - कुशल भारत



सत्यमेव जयते
GOVERNMENT OF INDIA
MINISTRY OF SKILL DEVELOPMENT
& ENTREPRENEURSHIP



N · S · D · C
National
Skill Development
Corporation

Transforming the skill landscape



1. Intr and Orienta

Unit 1.1 - Intr o Sewing and Apparel Sector

Unit 1.2 - Role and R wing Machine Operator

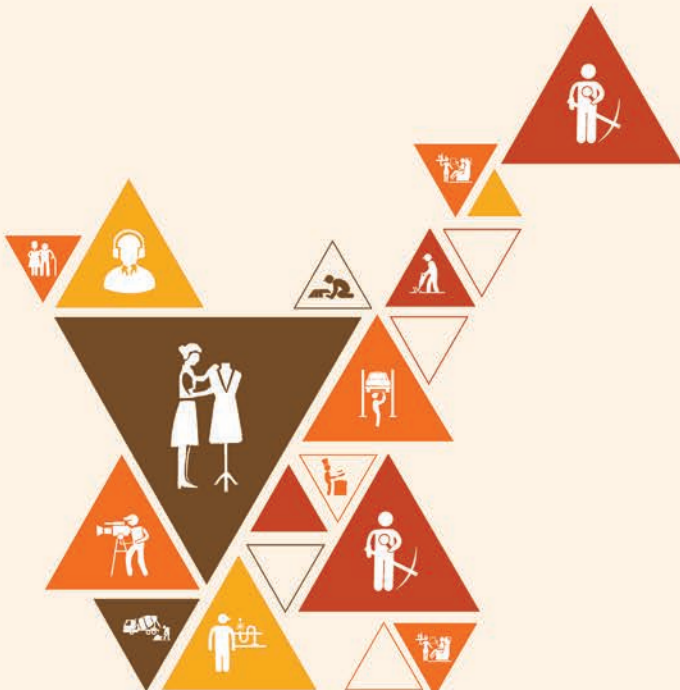

Key Learning Outcomes

At the end of this module, you will be able to:

1. Build rapport with fellow participants of the program
2. Discuss emerging trends in the sewing and apparel sector in India
3. Identify your roles and responsibilities
4. Familiarize yourself with the apparel industry
5. List the exact roles and responsibilities of a sewing machine operator and make the participants aware of the same.

UNIT 1.1: Introduction to Sewing and Apparel Sector

es 

At the end of the unit, students will be able to:

1. Introduce each other
2. Build rapport with fellow students and the trainer
3. Introduce the students to the art of sewing
4. Make the students understand the large world of Apparels and introduce them to the the areas that they do not know.

Resources to be Used

- Available objects such as a duster, pen, notebook etc.



- Make the students stand in a circle, close enough to the person each side of them that they can pass the parcel quickly.
- Say 'Stop' when the when students least expect it. The person who has the parcel at that should get out.
- Those who get out should introduce themselves by providing their names and a informa such as favourite hobbies, likes, dislikes etc.
- The winner of the game should stand and introduce himself/herself at the end of the game.
- Give the students the idea of how sewing can be seen as a new dimension of developing skill along with understanding their poten y introduce themselves.
- Make the students aware of the rising scope of the Apparel industry in India.

Say

- Thank the students f
- Ask them if they have any doubts
- Explain them the available scope in front of them.

Elaborate

Sewing is the craft of fastening or attaching objects using stitches made with a needle and thread. Sewing is the craft that leads to attach or fasten objects. It is one of the oldest existing arts in the world.

Apparel Sector – Industry Overview

Indian Textile and Clothing (Apparel) industry is the second largest manufacturer in the world. The Indian textile and clothing sector is expected to grow at 10.01 percent in the next 10 years from the current value of INR3.92 lakh crores in 2012–13 to INR10.54 lakh crores in 2021–22. Of these, the garments sector is expected to grow at an average rate of 15.44 percent over the years, thereby accounting for about 70 percent of the total production. The demand for domestic consumption for home textiles and garments is expected to increase rapidly. In fact, the garments sub-sector alone is expected to increase by seven times from INR 51400 crores in 2012–13 to INR3.70 lakh crores in 2021–22.

The Indian textile sub-sector has traditionally been contributing significantly to the economy and manpower as well as to the structural changes in the manufacturing sector. As of 2012, the sector contributed 4 percent of the GDP, 32 percent of the manufacturing sector and 9 percent of total exports. The sector's output is expected to grow at an annual average rate of 10 percent in the next 10 years, thereby increasing its worth to INR 10.5 lakh crores in 2022. Several factors that would contribute to the growth would include:

- Rising income levels are expected to increase the demand for home textiles and garments from domestic consumers is expected to increase.
- Free trade agreements provide India a comparative advantage in the export segment as compared to its competitors – China, Bangladesh and Pakistan – as they create opportunities for manufacturers to supply to potential markets in East Asia.
- Low production cost continues to be an advantage for the sector and, consequently, demand from existing foreign markets continues to increase.
- Structural changes in the sector, with a shift from vertically disintegrated to integrated large units with automated machines for yarn and fabric production.
- Increased spending on research and development to enter the specialized fabrics and technical textile sector.
- Favourable policy environment to support domestic and foreign investments and the implementation of schemes to enhance the production capacity and improve technology.

Ready Made Garments

The ready-made garments sector has grown rapidly in the last few years. Both exports and domestic demands shall drive sector growth in future.

The ready-made garments segment comprises men's, women's and kid's clothing, which may be used for either private (home/leisure) or commercial (uniforms for school, waiter and staff crew) purposes.

- Men's wear is the biggest segment in the ready-made garment segment, comprising about 43 percent of its share in the total revenue generated. This is followed by women's wear, with a share of 38 percent; 10 percent share of boys wear and 9 percent for girls wear in the total revenue generated by the ready-made garment segment.
- Changing lifestyles and consumption patterns are expected to drive the sector's supply of casual wear with an 11 percent growth, which would drive demand for workforce with specialised skills in western formals design, blended fabrics and increased application of technology on clothes.

Actual and Projected size of Indian Textile Industry

In 2011 global trade in textiles and apparel was around US\$ 705 billion. This was approximately 4% of the total global trade of all countries estimated at ~ US\$ 15 trillion. During the period 2000 to 2010 the textiles and apparel trade has grown at a modest CAGR of 6.4% per annum. Further, the Global Textiles and Apparel, or T&A, trade is expected to grow to USD 1 trillion by 2020.

- **Gujarat and Maharashtra:** Most large companies across all sectors of the value chain, including spinning, weaving, home textiles and garments, are located here. Key players include Aravind Mills, Raymond, Welspun, Bombay Dyeing, Alok, Century Textiles.
- **Karnataka and Kerala:** Bangalore and Mysore have a few garment clusters. Some major garment exporters include Gokaldas Exports and Shahi Exports.
- **Tamil Nadu:** Major clusters that serve as textile hubs are Tirupur, Coimbatore, Madurai and Karur; known for apparels, spinning mills, silk and home textile units, respectively. Key players include Loyal Textiles, KG Denim, Asian Fabric. Tamil Nadu accounts for the largest textile and clothing production of INR 761820 crores, which also employs the largest number of workers (2.63 million) in textile factories. This state is followed by Gujarat, which has an annual textile production valued at INR 49165 crores.
- **There are more than 70 textile and clothing clusters in India** account for about 80 percent of the total production. There are 39 power loom clusters and 13 ready-made garment clusters in India.
- **Bhiwandi and Malegaon** are the two largest power loom clusters. Major ready-made garments clusters are located in Delhi, Mumbai, Gurgaon, Nagpur, Madurai and Salem, with annual turnover of more than INR 1000 crores since 2003. The state of Maharashtra has 10 textile clusters. Other major states in terms of the number of clusters are Tamil Nadu, Andhra Pradesh, Karnataka, Kerala and Uttar Pradesh (seven clusters each).

Employment Scenario in the Sector

It also provides employment to approximately 35 million persons directly & approximately 55 million persons indirectly. India is among the very few countries which have presence across the entire supply chain, from natural and synthetic fibres right up to finished goods manufacturing. It has presence in organised mill sector as well as decentralised sectors like handloom, power loom, silk, etc.

Currently, 15.23 million people are employed in the textile sub-sector across yarn and fabric, home textile, technical textile and readymade garments. About one percent of the total workforce is engaged in the manufacturing of readymade garments, followed by yarn and fabrics with 26 percent. Human resource requirement in the sector is expected to reach

21.54 million by 2022 translating into 6.31 million additional employment during the period 2013-22.

Sub Sector	Employment in Millions	
	2017	2022
Spinning Weaving and Finishing of Textiles	3.14	3.18
Manufacture of Other Textiles	10.64	13.78
Manufacture of Wearing Apparel	4.28	4.58
Overall	18.06	21.54

Fig 1.1.1: Sub-Sectors in Apparel Industry

Made-ups and Home Furnishings

The made-ups sub-sector is growing at a steadily increasing pace in the country. The wide variety of products that come under this sub-sector are not only include but also and luxury products. Made-ups sub-sector is divided into three (3) broad categories:

Indian is among one of the biggest exporters in Apparel and Made-ups industry. In Home Tex India is second only to China in global exports, whereas in apparels, India is among the top 10.

Product	Total World Export	Major Contributor			India's Con		Other Compe Countries
		Country	Share & Value	Ranks	Share & Value	Ranks	
Apparel	193400159	China	61224360 (31.65%)	1	7429975 (3.8%)	7	Italy, Bangladesh, Hong Kong, Vietnam
Home Tex	55921991	China	24015853 (42094%)	1	3973042 (7.10%)	2	

Fig 1.1.2: Textile Exports by Major Countries and India ('000 USD) * Source NSDC Skill Gap Study – Textile & Clothing

As evident from the Figs above, India is fast becoming one of the leading global players in the Home Furnishings/ Tex Home Furnishings industry ers wide varie of products like bedspreads, furnishing fabrics, curtains, rugs, cushion covers etc. Indian Home Furnishings Market is forecasted to increase at an annual growth rate (CAGR) of 8 percent over next e years. The industry will reach a value of approximately US \$5.29 billion by 2018. The Indian Home Furnishing industry provides a unique blend of modern technology and ethnic techniques to bring out products that are one of the best in the world. The increase in the spending power of the Indian working class is also expected to contribute in the growth of domes consump of made-ups and home furnishings industry

With increased demand and comple from countries like China, the demand of skilled workforce/kaarigars in the Home Furnishings industry is bound to increase in coming years.

Notes for Facilitator



- You could ask the students who get out during the game to be the music keepers. They can start and stop the music as the game progresses.
- Encourage shy students to provide informa about themselves by promp them with ques such as 'what do you enjoy doing the most', 'what is your favorite movie or book' etc.
- Advise the students as to how can they enhance their skills and stand out the crowd in the compe e world.

Sugges e ques o ask students:

- Ask students to explain the employment scenario in the sector.
- Ask students to explain the actual & projected size of Indian Tex try.

UNIT 1.2: Role and R

ewing Machine Operator

es 

At the end of the unit, students will be able to:

1. Know who is SMO
2. Understand the roles and r

Resources to be Used

- Available objects such as a duster, pen, notebook etc.

Say 

- Thank the students f
- Ask them if they have any doubts
- Explain them the available scope in front of them.

Elaborate 

Sewing Machine Operator- Job Descrip

Sewing Machine Opera involves s ching of components of garments together using a sewing machine. The role of a sewing machine operator is ver al to the industry as it enhances the quality of the product.

A Sewing Machine Operator, also called a cher or Machinist' is an important job-role associated with Apparel sector. The primary responsibility of a machinist is to s ch/ sew fabric, fur, or synthe materials to produce apparels.

A es: A Sewing Machine Operator is associated with the Apparel sector. His/her primary responsibility is to sew and/or s ch fabric, synthe materials or fur to produce apparel. A Sewing Machine Operator should be visually and physically This includes a strong hand-eye-leg coordina and eyesight that is perfect both in near, distance, color, peripheral vision, ability to change focus and depth percep Sewing machine operators also adjust machine controls and regulate s ching speeds for every sewing project that they work on. It is important for sewing machine operators to possess in depth knowledge of sewing machinery and the garments industry. They also need to have sound hand-eye coordina and be able to cope with moderate physical e ort.

- It is important to strictly refer to the clients' orders and accordingly use the best suited material.
- Ascertain that all supplies (auxiliary and essential) and materials are ready at hand before beginning the assignment.
- The machine should be started as per the instructions provided in the manual.
- Address any discrepancies or problems faced during the test.
- According to the sewing project, the machine settings should be adjusted and threads should be drawn through needles.
- Materials should be placed properly and aligned under the needles to sew them together.
- It is crucial to replace needles and also rethread them for other projects in the future or in case the needle needs more thread for the ongoing project.
- Any defects or faults in stitching should be avoided by closely observing the operation.
- Report any supervisors of any problems or discrepancies during the sewing process.
- It is important to make sure that the product created should conform to the design demands and merchandising instructions mentioned in the order for the assignment.
- All excess threads and materials should be neatly cut away from the product.
- Perform general and preventive maintenance tasks on sewing machines to ensure their longevity.
- Examine the garments for compliance and ensure that appropriate tags are sewed on them.
- Count number of garments and record this information in the company provided logs.

Notes for Facilitator



- Summarize the main points.
- Encourage students if they have any doubts. Encourage them to ask questions.
- Answer their queries satisfactorily.
- Try to complete the questions at the end of the unit.
- Ensure that every student answers all the questions.

Suggested questions to ask students:

- Ask students to explain the roles & responsibilities of a Sewing Machine Operator.



Skill India
कौशल भारत - कुशल भारत



सत्यमेव जयते
GOVERNMENT OF INDIA
MINISTRY OF SKILL DEVELOPMENT
& ENTREPRENEURSHIP



N · S · D · C
National
Skill Development
Corporation

Transforming the skill landscape



2. Carryout ching Using Machine or By Hand

Unit 2.1 - Prepare f ching Opera

ch Components to Produce Apparels

ching a Trouser

ching a Shirt

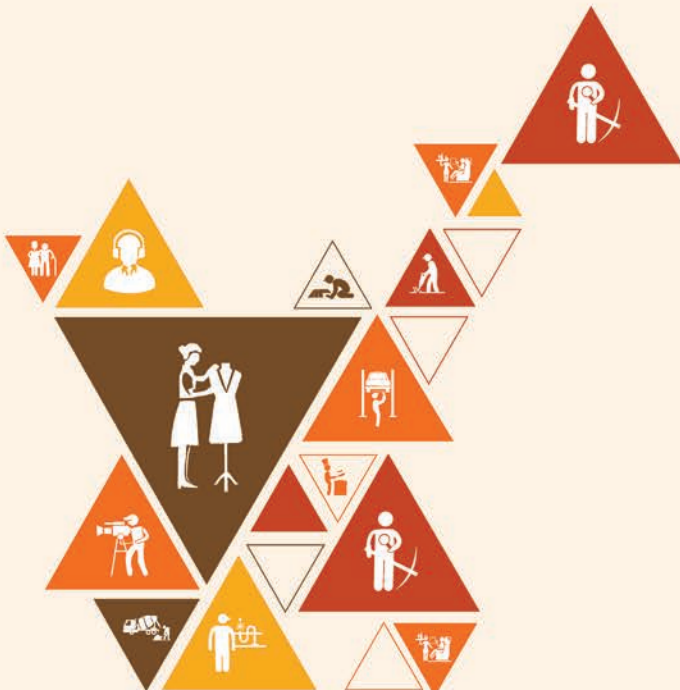

AMH/N0301

Key Learning Outcomes

1. At the end of this module, students will be able to:
2. Recognize different types of industrial sewing machines.
3. Familiarize with the feed mechanisms.
4. Determine the basic list of material and tools required for sewing.
5. Check the equipment is safe and set-up in readiness for use.
6. Recognize different types of threads and needles.
7. Adjust the machine.
8. Ask questions to obtain more information.
9. Estimate the expected length of the process.
10. Perform a test sew run.
11. Know different types of sewing and seam.
12. Sew a trouser and shirt.

UNIT 2.1: Prepare for Sewing Operation

Objectives

At the end of the unit, students will be able to:

1. Recognize different types of industrial sewing machines.
2. Familiarize with the feed mechanisms.
3. Determine the basic list of material and tools required for sewing.
4. Check the equipment is safe and set-up in readiness for use.
5. Recognize different types of threads and needles

Resources to be Used

- Available objects such as black or white Board, chalk pieces or white board marker pens, duster
- PC with LCD Projector or Flip Chart
- Copies of handouts, Participants Handbook

Do

- Greet and welcome students to the next session of the program.
- Before starting, ensure they have any doubts pertaining to the previous unit.
- Capture their responses on board and share them wherever necessary.
- Tell them that they will learn about Finishing Department Work

2.1.1: Industrial Sewing Machine

Say

- The industrial sewing machine is a substantial duty form of a typical home sewing machine. It is used in the apparel and other industries related to it such as furnishings sewing. One of the most common uses for the industrial sewing machine is to make the mass production sewing of pockets into articles made out of heavy fabric, like denim for blue jeans.

Do 

- Explain to students the need and purpose of the machine.
- Call a volunteer and demonstrate these processes.

Demonstrate 

Call a volunteer and outline the steps

- Demonstrate the process of using the machine.
- Demonstrate the various types of industrial sewing machines.

Types of Industrial Sewing Machines

- Flatbed
- Cylinder-bed
- Post-bed
- Raised-bed
- F
- Lockstitch machine
- Overlock wing machine
- Overlock Machine
- Flatlock machine
- Non A lock machine

Summarize 

Summarize the feed mechanism of various kinds of machines.

- Identify the different parts of a sewing machine.
- Provide the students a list of all the materials required for sewing that includes scissors, rotary cutter, thread, measuring tape, needles, fabric, pins, pincushion, iron and ironing board, seam ripper, pinking shears, seam gauge, table, sewing gauge, hem gauge, yards, hip curve, L-Square, Tailor's Chalk, novelty yarns, masking tape, French curve, hand needle, punch needle, round frame, pattern making paper, tracing paper, hand held trimmer, bent neck metallic tweezers, 2B and 4B pencils, pick glass, needle threader, non woven non-fusible backing paper, hand embroidery book, fabric glue, surface ornamentation material, buttons, hooks, trims, lace, zipper, pant hooks, sewing mannequin, grayscale and thimble.
- Give a detailed explanation on machine attachments and work aids. Tell them that work aids are devices which are built into machines, added to them afterwards, attached alongside or made use of in whatever ways a resourceful engineer can devise to improve productivity, improve or maintain quality standards, reduce time and effort for the operator.

- Work Aids can be divided into the following categories:
 - » Folders
 - » Binder
 - » Hemmer
 - » Pressure foot
 - » guide
- Explain the different types of threads to the students namely long , spun thread, and double spun thread. The various threads include rayon, polyester, nylon, cotton, wool, and so on. The parts of a needle have to be explained to the students.



Conduct a skill pr

- Ask the students to assemble together.
- Explain the purpose and dura
- Set guidelines pertaining to discipline and expected tasks

Skill Pr	Time	Resources
Oral Examina erent things taught	1 hour	Sewing Machine, Thread, Accessories, Needles, and other materials.

Notes for Facilita



- Summarize the main points.
- ts if they have any doubts.
- Encourage them to ask ques
- Answer their queries sa factorily.
- T ts to complete the ques t the end of the unit.
- Ensure that ever t answer all the ques

Sugges e ques o ask students:

- Ask students to name types of Industrial Sewing Machine.
- Ask students to e erent parts of a Sewing Machine.

Key Components to Produce Apparels



At the end of the unit, students will be able to:

1. Adjust the machine.
2. Ask questions to obtain more information.
3. Estimate the expected length of the process.
4. Perform a test sew run.
5. Know different types of stitching and seam.

Resources to be Used

- Available objects such as black or white Board, chalk pieces or white board marker pens, duster
- PC with LCD Projector or Flip Chart
- Copies of handouts, Projects Handbook



- Do**
- Greet and welcome students to the next session of the program.
 - Before starting, ensure they have any doubts pertaining to the previous unit.
 - Capture their responses on board and share them wherever necessary.
 - Tell them that they will learn about Finishing Department Work.



- Say**
- Recite to them the various steps of adjusting the machine before starting.
 - The steps include:
 - » Threading
 - » Using the Bobbin Winder
 - » Replacing the needle and
 - » Forming the stitch.

Demonstrate

Demonstrate them the various steps of adjus

fore st

Steps to Thread the Sewing machine

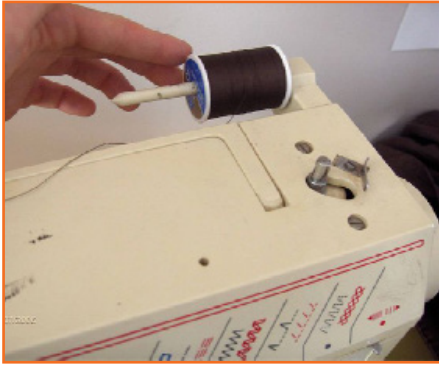

Step 1: This is where the thread goes. If you have a cap or stopper put it on after you put the thread on. Also put the side of the thread with the

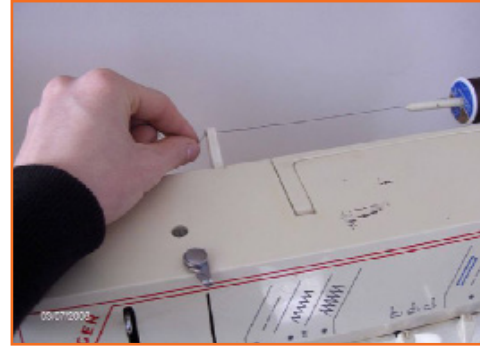

Step 2: Allow the string to unwind and put it through this hoop. Mine can also snap in from the back but usually with older machines this is a hoop.



Step 3: This can also be a loop but mine slides in through the back.

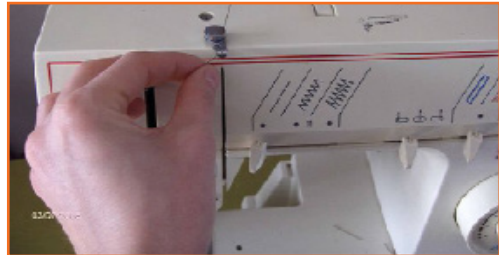

Step 4: From the tension bring the thread up and from right to left put it through the hole here.



Step 5: Then bring it down from the take up lever into the coiled thread guide.



Step 6: Then into the next thread guide.



Step 7: Then thread the needle front to back or right to left depending on your machine. Pull enough thread through so that it does not pull out when the needle moves 5-10 inches.



Step 8: Insert the bobbin.



Step 9: Pull the string out and set the bobbin into the tray. Insert the thread into the metal notch and pull back.

Using the Bobbin Winder

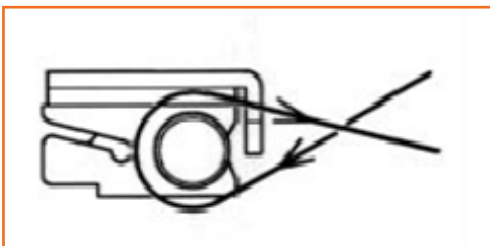

- Step 1:**
- Place spool of thread on spool pin.
 - Slide spool pin holder/cap over rim of spool to prevent thread from tangling.
 - Push bobbin winder pin to far left if it is not already there.
 - Pass the thread from spool through thread guide

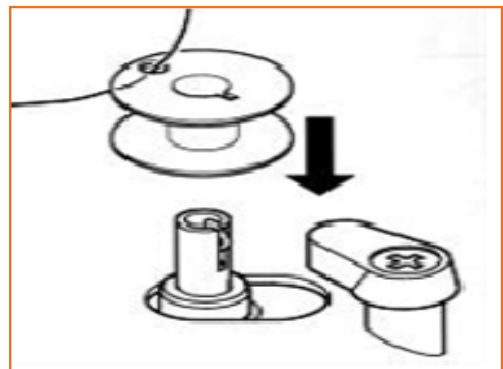

Step 2: Pass thread end, from inside, through small hole in rim of bobbin

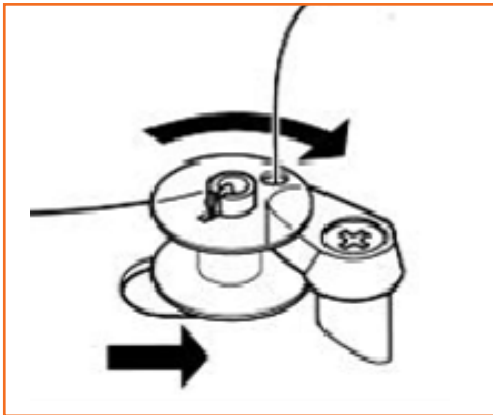

- Step 3:**
- Place bobbin onto pin.
 - Push bobbin winder pin to the right. This will stop the needle from moving.

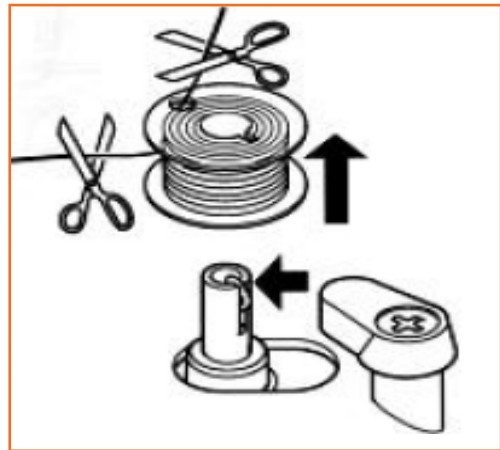

- Step 4:**
- Holding thread end, step on speed controller to run machine until desired amount of thread is wound.
 - Cut thread; push bobbin to the left and remove it from bobbin winder pin.

Elaborate

- Elaborate Treadles.

A treadle is a part of a machine which is operated by the foot to produce reciprocal or rotary in a machine such as a weaving loom (reciprocal) or grinder (rotary). Many of the early machines were powered by a treadle mechanism. The treadle was operated by pressing down on it with a foot, or both feet, to cause a rocking movement. This movement spins a large wheel on the treadle frame, connected by a thin leather belt to a smaller driving wheels on the sewing machine.

- Explain the tension adjustment with the adjustments that tension adjustment is done to make a basic adjustment, adjust the bobbin spring; tighter if the bobbin thread shows on the upper layer, and looser if the needle thread shows on the under layer.

Demonstrate

It always happens. You're pushing that fabric through, pushing that pedal to the grindstone, and it happens. You hear the loud pop and feel a sharp prick against your face or arm. You've broken a needle. But there's no use crying over a broken needle. They're fast and easy to replace, as long as you have some back up needles around. Nowadays, sewing machines use universal needles about every machine.

Replacing a Needle

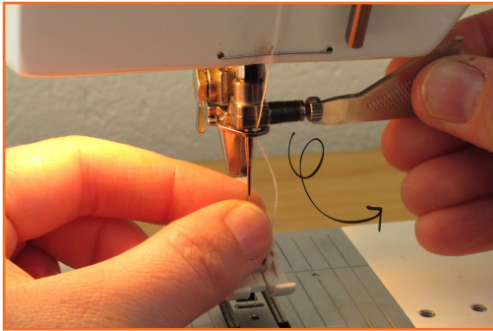

Step 1: Hold the needle with your left hand and undo the screw at the top of the needle with your right hand.



Step 2: Remove the needle by pulling down and away from the needle clamp.

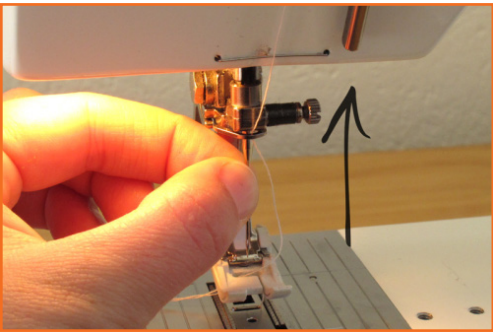

Step 3: With the flat side towards the back, push the new needle up inside the needle clamp as high as it will go.

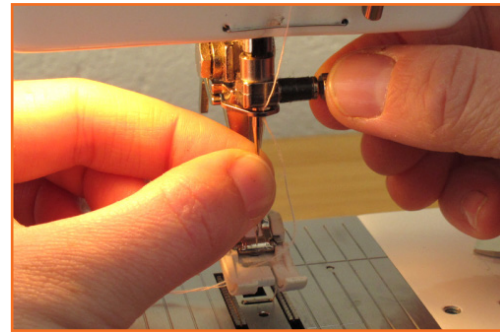

Step 4: Use your fingers in front and then your tool of choice to tighten the needle clamp screw. The tighter you can make this, the better. A loose clamp may leave the needle down in the fabric you are sewing.



Step 5: Re-thread your needle, pushing the thread from front to back.

Elaborate

- Explain with the _____ ts the s ch forma _____. Tell them that the lock s ch uses two threads, an upper and a lower. Lock s ch is so named because the two threads, upper and lower, "lock" (entwine) together in the hole in the fabric which they pass through. The upper thread runs from a spool kept on a spindle on top of or next to the machine, through a tension mechanism, through the take-up arm, and _____ through the hole in the needle. Meanwhile the lower thread is wound onto a bobbin, which is inserted into a case in the low _____ w the material.
- Explain the presewing _____ with the _____ ts. Ask them that before sewing a garment, the sewing machine operator should:
 - » Check that equipment is safe and set up in readiness for use. Perform a machine, needle and spool check. Do a sample run to check thread tension.
 - » Check that the materials to be used are free from faults. Go through all the material required for cons _____ arment. Do fabric, thread and trims checking before sewing.
 - » Ensure the materials used meet the _____ a _____ matching. Go to through the spec sheet and make sure the materials mee _____ a _____ ovided by the buyer.

Ask

Tell the _____ ts to ask ques _____ to obtain more informa _____ on tasks when the ins _____ are unclear and _____ e the s ching op _____ with supervisor. P _____ ts can ask ques _____ to supervisor for the following queries:

- It is important to ask ques _____ rather to act like a dumb or a super heroic _____ e to the group or the team at your work place.
- It is important to play a _____ en _____ while demonstra _____ or details are been given/taught on how to perform your certain job role, however even if you haven't been told or maybe you were unable to understand at once, it's always suggested.
- As a sewing machine operator it is very important for you to be pr _____ e at all _____ like pr _____ e in learning or asking things you aren't sure about and pr _____ e and s _____ orking as well.
- Flawless working can be a _____ ined only if you put in endless e _____ orts of pr _____ or clearing all your doubts when and wherever you require.
- Even if you think it's the silliest thing ever which I have not understood or people would make fun of; ignore that thought right then and there. Ask! It's much be _____ er to ask rather to keep quiet.
- When you are not clear about the ins _____ like what and how you have s _____ ch any _____ garment it's always suggested to look for a team leader or a supervisor for guidance and help on the subject.
- If you feel hesitant in directly approaching your supervisor tell them to make you sit with someone who is e _____ t in the work so that you can learn from one of the group mates at your ease.
- More you ask, more e _____ t you become.
- Asking the query of any sort of doubt like non-understanding of the subject or any un-cleared / confusing statements can also help using the resources right way and not just was _____ them trying rather than asking the e _____
- It is okay to ask even a _____ er the training period if you are un-sure about any statement related to your role in the industry / company.

Demonstrate

Perform a Test Run



Step 1: Cleaning and oiling: Check if the machine is been cleaned and oiled properly. With the presser foot up, try to run the machine at full speed for one minute. If you hear a discrepancy in speed then the machine surely needs some lubrication. Remove the top cover (if machine has one.) If not, you should be able to reach the holes on top of it. Apply only a drop of SEWING MACHINE OIL (not 3 in 1 oil or any other kind of oil or rust inhibitor). Next, reach the top of your machine. After removing any dust, lint, broken needles debris and straight pins, apply a drop of oil to each moving part. By turning the hand wheel slowly (always towards you for 98% of them), you will see all the moving parts joints that needs to be oiled. Many parts already have a small hole especially for oiling.

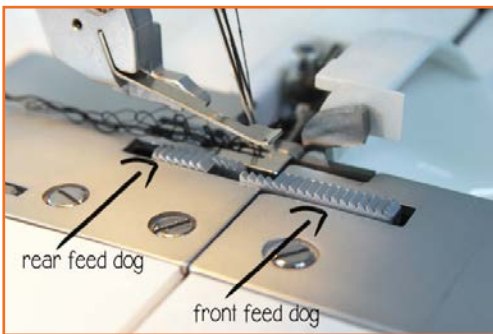

Step 2: **Check feed dogs:** Remove the feed dog, clean the feed dogs. Try to pass a rag under them and with an old needle or narrow tool, remove the lint inside the feed channels. Put back the needle plate. If your machine is equipped with a FEED DROP, be sure the feeds are set at UP. By turning the hand wheel (towards you), check to see if the feeds make their movement.



Step 3: **Look for upper tension:** Most sewing machine problems are caused by thread tension. Learn this basic principle right now: the upper tension determines your UNDER stitch. And the bobbin (bottom) tension determines your UPPER stitch. Unless you are experimented to dismantle the upper tension unit or if it's explained in your manual, follow this simple technique. Tension discs are often disrupted by pieces of broken thread, lint and dust. This cause a gap between the tension discs and no pressure is applied to the thread resulting in thread loops underneath. Take an 8" length of thread and make 3 to 4 knots in it (as pictured below). Thread your tension system with this piece of thread a few inches in all directions. This will remove any lint residue between the tension discs. Try it for the first time with the presser foot UP and then with the presser foot DOWN. When the presser foot is down and the tension dial set at number 4, you should be able to feel a tension when pulling the thread. If so, the upper tension system is working properly.



Step 4: The bobbin: Check also for the condition of the bobbin winder rubber foot. If you can see cracks and worn flat surfaces, replace it. This very popular item is available at any sewing shop for a dollar or so. When winding a bobbin, check to see if the thread winds evenly from each side of the bobbin. Then check the tension of your bobbin case. Remove any lint pancake. Install your bobbin in it. By pulling the thread, you should feel a very firm tension on the thread. If not, some clogged lint may be lying between the small tension spring and the bobbin case itself.

- Note the following steps to perform the test run (Again).
- Ensure that they must experience the following observations to make sure the machine is working properly.
 - » Firstly, run the machine at medium speed for a few straight rows.
 - » Check underneath: the stitches should be identical to the top one. No loops, only a tight stitch. If any loops are found underneath, raise the upper tension slightly and make a second straight row.
 - » Try also the reverse stitch a few times while sewing (do not stop to engage the reverse). Make sure the thread does not break. Check also for loops underneath on the stitches made with the reverse.
 - » If everything is good so far, run the machine at full speed making a few straight rows. If your machine is equipped with the zigzag, try it. The zigzag stitches should be the same on top and bottom.



- If everything is good so far, run the machine at full speed making a few straight rows. If your machine is equipped with the zigzag, try it. The zigzag stitches should be the same on top and bottom.
- The seam classes should be explained to the students. These include:
 1. Class 1 – Superimposed seam
 2. Class 2 – Lapped seam
 3. Class 3 – Bound seams
 4. Class 4 – Flat seams
 5. Class 5 – Decorative/Ornamental stitching
 6. Class 6 – Edging/finishing
 7. Class 7 – Attaching of separate items
 8. Class 8 – Single ply construction

Demonstrate

- Let students practice different types of stitches.

Perform a Lockstitch

- Step 1:**
- Keep the slide plate open so that the hook-set is visible.
 - Bring needle to its lowest position into the hole through which it reaches the bobbin by slowly moving the hand-wheel.
 - Now, move the needle up using the hand-wheel
 - Needle-thread (Upper-thread) becomes loose when the needle goes up from this lowest position
 - Blade point of outer hook of the bobbin assembly catches the loop-shaped upper thread and pulls it.
 - Upper thread is then separated at the inner hook thread separator
 - So the needle-thread is taken up by the opposite (or rear) inner hook.
 - At the same time, needle-thread on cloth side is separated to the right side of inner hook.

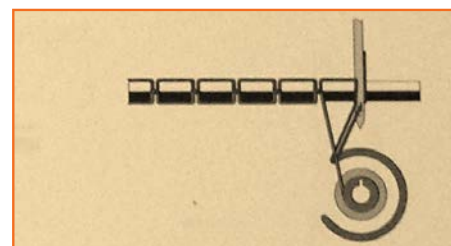
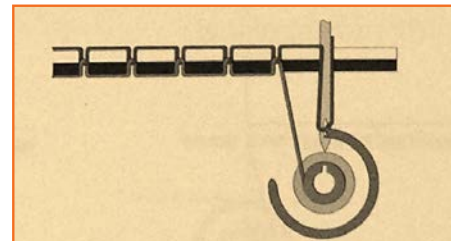

- Step 2:**
- Keep the slide plate open so that the hook-set is visible.
 - Bring needle to its lowest position into the hole through which it reaches the bobbin by slowly moving the hand-wheel.
 - Now, move the needle up using the hand-wheel
 - Needle-thread (Upper-thread) becomes loose when the needle goes up from this lowest position
 - Blade point of outer hook of the bobbin assembly catches the loop-shaped upper thread and pulls it.
 - Upper thread is then separated at the inner hook thread separator
 - So the needle-thread is taken up by the opposite (or rear) inner hook.
 - At the same time, needle-thread on cloth side is separated to the right side of inner hook.

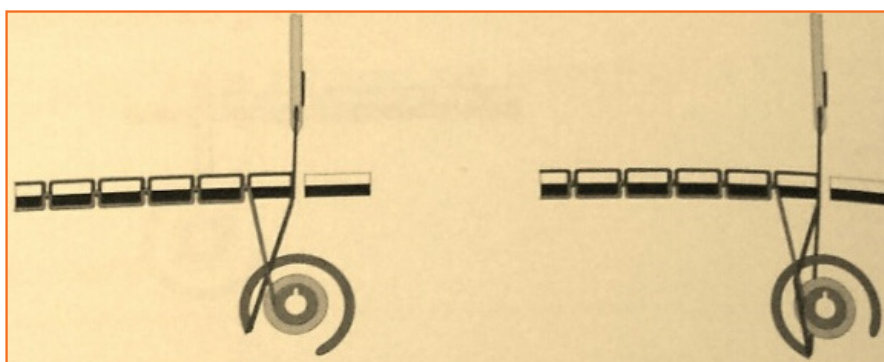
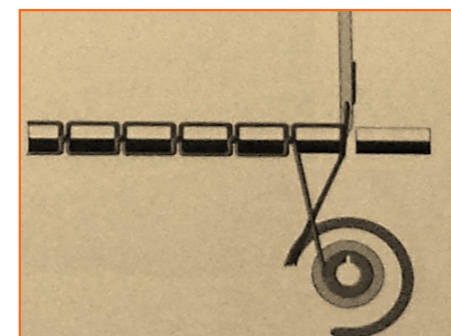

- Step 3:**
- Thus the upper thread is lockstitched (interlaced) with the lower thread.
 - Stitch formation is completed when the upper thread meets the lower thread.
 - The feed dog pushes the upper thread forward.
 - The needle comes down and goes inside the cloth to repeat from step 1 to 14.

Perform a Chain Stitch

- Step 1:**
- Needle is the lowest
 - Upper thread becomes loose when needle goes up from its lowest
 - Needle-thread (upper thread) becomes like a loop then the looper catches the needle thread.
 - The needle enters the loop of needle-thread which is widened by the looper.

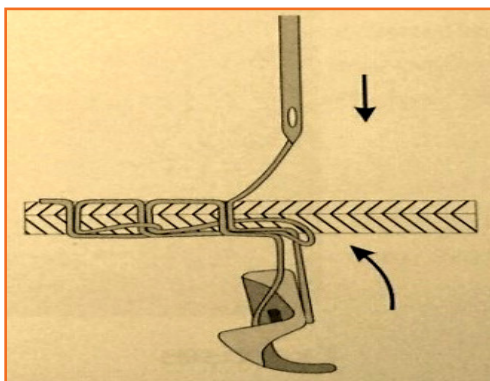
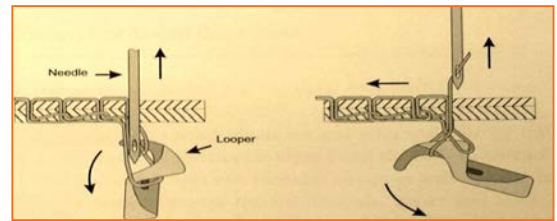

- Step 2:**
- The needle moves up and comes out of the cloth and the unsched part of cloth is pushed forward to form a chain.
 - The looper rotates and removes the loop of the needle-thread it had caught.
 - Also the looper keeps pulling in the needle-thread as it rotates.

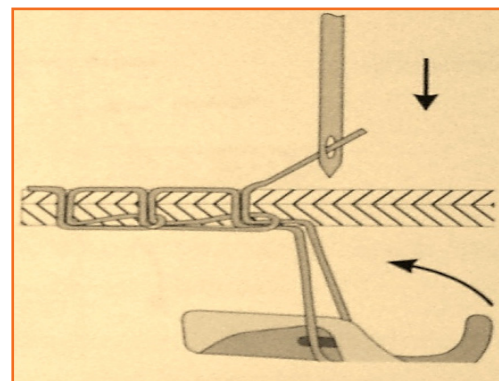

- Step 3:**
- Looper keeps rotating and pulls thread towards its own centre
 - Thread take-up lever tensions the earlier loop of thread which the looper removed in step 2.
 - Cloth feed is finished (feed dog has finished one cycle of feeding) and a chain is formed
 - Needle again pierces into the cloth and continues to form the next chain repeatedly.

Demonstrate

Try to demonstrate how to Perform Chain Stitch at Normal Speed

Now let's see how to stitch at the normal speed:

- **Step 1:** Attach needle and thread the machine – needle-thread and bobbin-thread.
- **Step 2:** Adjust thread tension using a rough fabric.
- **Step 3:** Put the fabric sample at the left.
- **Step 4:** Note the start point to start sewing exercise.
- **Step 5:** Pull the fabric sample with the left hand.
- **Step 6:** Raise the presser foot.
- **Step 7:** Place the fabric sample under the presser foot such that the start point of the chain line is exactly below the needle point. (Fig 2.2.47)

- **Step 8:** Lower the presser foot.
- **Step 9:** Press the pedal down with the toe of the right foot.
- **Step 10:** Continue to press the pedal down with more force such that machine runs at normal speed (i.e. high speed).
- **Step 11:** Guide the sample with your hands as it moves forward.
- **Step 12:** maintain stitching line along the marked straight line.
- **Step 13:** Stop sewing-machine at the stop mark.
- **Step 14:** Press the back part of the pedal down with the heel of the left foot.
- **Step 15:** Raise the presser foot and pull the sample out.
- **Step 16:** Hold the trimmer in the right hand and trim the threads.
- **Step 17:** Properly repeat from step 6 to 16 for all 10 lines on the sample.
- **Step 18:** After complete remove the sample from the machine to the table.
- **Step 19:** Not

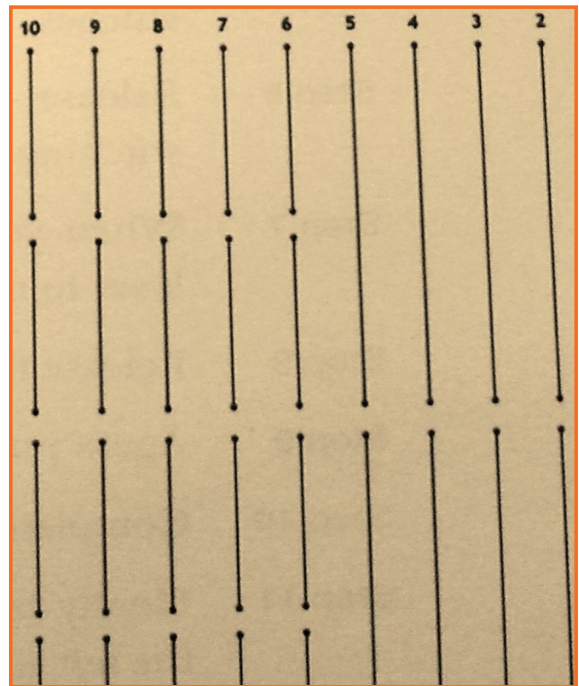

ch

- **Step 1:** Attach needle and thread the machine- needle-thread and bobbin- thread.
- **Step 2:** Adjust thread tension using a rough fabric.
- **Step 3:** Put the fabric sample at the left.
- **Step 4:** Note the starting point to start sewing exercise.
- **Step 5:** Pull the fabric sample with the left hand.
- **Step 6:** Raise the presser foot.
- **Step 7:** Place the fabric sample under the presser foot such that the start point of the stitching line is exactly below the needle point.
- **Step 8:** Lower the presser foot.
- **Step 9:** Press the feed control lever (Reverse stitching lever) to its lowest position.
- **Step 10:** sew 2-3 reverse stitches at low speed.
- **Step 11:** Stop stitching.
- **Step 12:** Release the reverse stitching lever so that the machine can do regular sewing (forward direction).
- **Step 13:** Start sewing at normal speed i.e. high speed.

- **Step 14:** keep sewing along that line.
- **Step 15:** Slow down the speed when the corner comes near.
- **Step 16:** Stop sewing at the corner point.
- **Step 17:** Lower the needle at the corner.
- **Step 18:** Raise the presser foot.
- **Step 19:** keeping the needle in dropped or lowest (pierced inside the fabric sample), turn the fabric sample.
- **Step 20:** Align the fabric sample such that the sewing line drawing (after the corner stop point) is in line with the needle point and sewing line.
- **Step 21:** Lower the presser foot.
- **Step 22:** Sew straight stitches.
- **Step 23:** Repeat Step 14-22 at every corner. (Fig 2.2.49)
- **Step 24:** Stop sewing at the sewing end symbol.
- **Step 25:** Press the back part of the pedal down with the heel of the left foot.
- **Step 26:** Raise the presser foot and pull the sample out.

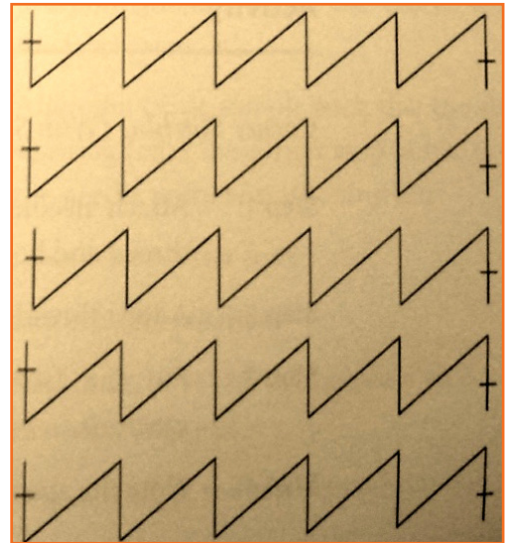

Curving (Left and Right Curve)

- **Step 1:** Attach needle and thread the machine- needle-thread and bobbin- thread.
- **Step 2:** Adjust thread tension using a rough fabric.
- **Step 3:** Put the fabric sample at the left.
- **Step 4:** Note the starting point to start sewing exercise.
- **Step 5:** Pull the fabric sample with the left hand.
- **Step 6:** Raise the presser foot.
- **Step 7:** Start sewing at the outermost semicircle of the curves on the left.
- **Step 8:** Place the fabric sample under the presser foot such that the start point of the first line is exactly below the needle point.
- **Step 9:** Lower the presser foot.
- **Step 10:** Press the pedal down with the toe of the right foot.
- **Step 11:** Continue to press the pedal down with more force such that machine runs at a normal speed (high speed).
- **Step 12:** Guide the sample with your hands as it moves forward to keep the sewing on the drawn curve.
- **Step 13:** maintain sewing line along the marked curve.
- **Step 14:** Stop sewing-machine at the stop mark.

- **Step 15:** Press the back part of the pedal down with the heel of the left foot.
- **Step 16:** Raise the presser foot and pull the sample out.
- **Step 17:** Hold the trimmer in the right hand and trim the threads.
- **Step 18:** Proceed by repeating from step 6 to 16 for all 7 curves on the sample.

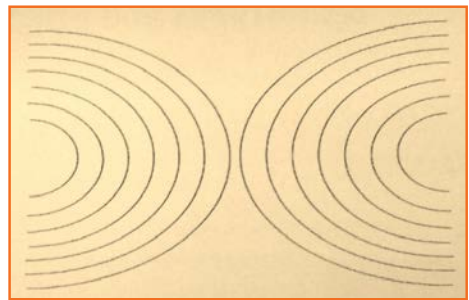

- **Step 19:** Now, proceed with sewing along the outermost right curve on the worksheet by repeating step 6 – 16 for all 7 right curves.
- **Step 20:** Note the hand movement that helps guide the fabric which must change according to the change in the direction.
- **Step 21:** Eventually remove the sample from the machine to the left.
- **Step 22:** Not



- Conduct an apparel manufacturing unit.
- Make the students analyse how an SMO adjusts sewing machine like threading a machine, attaching bobbin to machine and replacing needle.
- Make the students understand the different types of stitches and which type of stitch suits to different fabrics.

Notes for Facilitator



- Summarize the main points.
- Encourage students if they have any doubts.
- Encourage them to ask questions.
- Answer their queries satisfactorily.
- Try to complete the questions at the end of the unit.
- Ensure that eventually answer all the questions.

Suggested questions to ask students:

- Ask students to replace a needle.
- Ask students to Perform a Test Run.

(Suggested Note) As per students give practical questions our choice to understand the student's outcome.

Finishing a Trouser

Objectives

At the end of this unit, the students should be able to:

1. Recognize different parts of a trouser.
2. Finish a trouser

Resources to be Used

- Available objects such as black or white Board, chalk pieces or white board marker pens, duster
- PC with LCD Projector or Flip Chart
- Copies of handouts, Patternists Handbook

Do

- Greet and welcome students to the next session of the program.
- Before start, students may have any doubts pertaining to the previous unit.
- Capture their responses on board and share them wherever necessary.
- Tell them that they will learn about Finishing Department Work

Elaborate

- Teach the students the parts of a trouser.
- Explain the mechanism of attaching a pocket.
- Demonstrate the process of Fly making and attaching the same.
- Show the mechanism to attach a zipper.
- Demonstrate the process of attaching the back rise.
- The process of making the belt loop also needs to be explained.
- Finally explain the way to finish the hem.
- Demonstrate the process of ironing, and bartacking should be shown.

Demonstrate

Preparation of Pocket Bag (Front)



Step 1: Take both the upper facing pieces and put overlock stitch on the longer straight sides. Make sure the face side of the pieces is on top.



Step 2: Take both the lower facing pieces and put overlock stitch on the curved sides. Again, make sure that the face side of the pieces are on the top.

- Note the notch marks on the lower facing pieces.
- Note that the overlock stitch is on the curved side.



Step 3: Take both of the pocket bag pieces and both upper facing pieces. Keep the upper facing piece over the pocket bag in such a way that the overlock part is facing inside and the stitch is facing upwards.

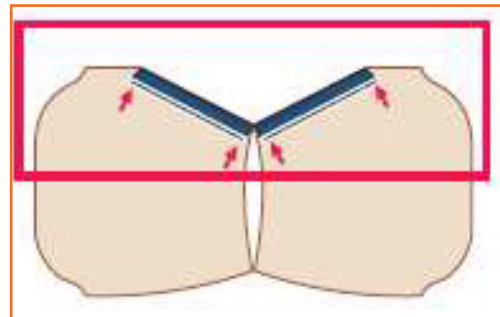

Step 4: Put overlock stitch at the edge of the overlock stitch.



Step 5: Take both the lower facing pieces and keep them over the other side of the pocket bag.



Step 6: Put the overlock stitch at the edge of the overlock curved side.

Pocket A attaching (front)



Step 1: Take the two front pieces and keep them on the sewing Fig with the face side up.

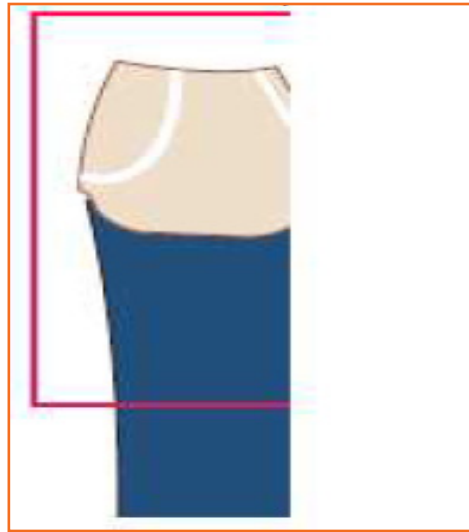

Step 2: Take the pocket bag and place it over the left front piece aligning with the mouth of the pocket.

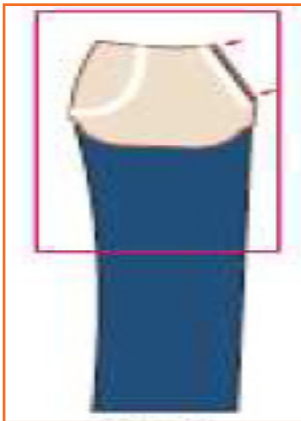

Step 3: Put 6 mm slash taking $\frac{1}{4}$ line on throat plate as guide, starting from the top to bottom.



Step 4: Turn the piece and put 4 mm slash at the mouth of the pocket.



Step 5: Match the lower facing and upper facing at the notches.



Step 6: Put 2 mm slash starting from the waistline to the outer side of the left front piece.



Step 7: Put 5 thread overlock stitches on the curved edge of the pocket bag.

Step 8: Take the other pocket bag and place it over the right front piece aligning with the pocket bag (face to face).

Step 9: Repeat steps 3-7 for the right hand side pocket.

Pocket A Matching (back)

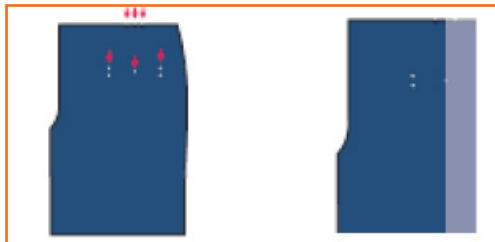

Step 1: Take a note of the notch marks and the pocket marking on the back piece.

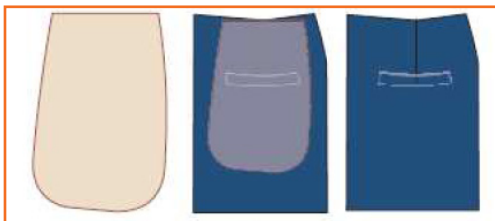

Step 3: Take one of the back pocket bags. Place it below the back piece in such a way that the top end of the back piece and the pocket bag are perfectly aligned. Make sure that pocket bag is aligned centrally to the dart.



Step 2: Fold the fabric at the centre notch mark and make a dart by stitching to the notch marking.

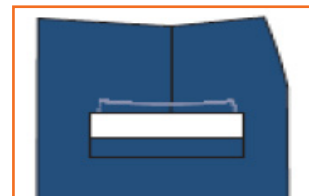

Step 4: Take one of the fused bone pieces and place it over the pocket markings in such a way that the top marks are visible and the bottom marks are covered by the bone pieces and are at equal distance from both sides.

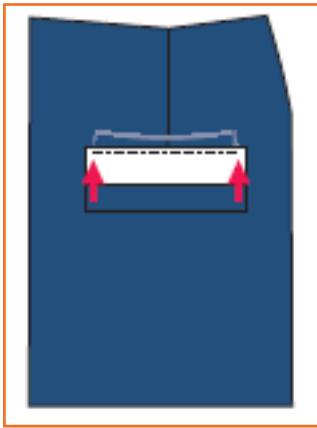

Step 5: Now put a 6 mm seam from back rise side towards the side seam side. The seam should be at the notch mark side. Put back tack, both at the beginning and end of the seam.

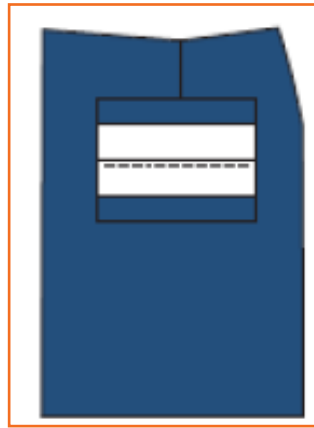

Step 6: Take the second fused bone piece and place it next to the stitched bone piece on the waist side.

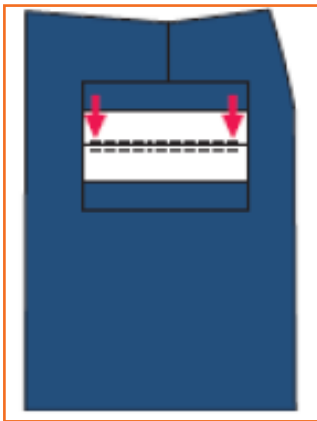

Step 7: Put 6 mm seam from the side-seam side towards the back rise side.

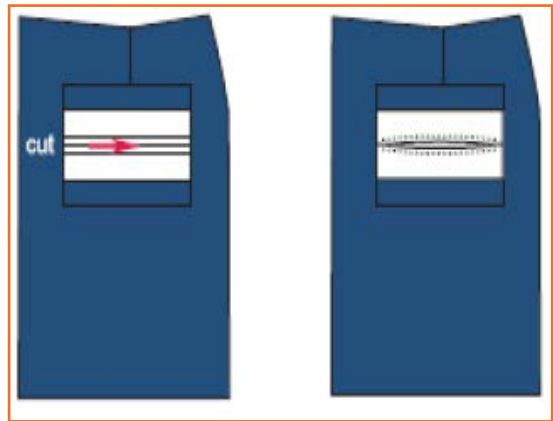

Step 8: Cut the fabric between the two bones leaving 10–12 mm on both sides.

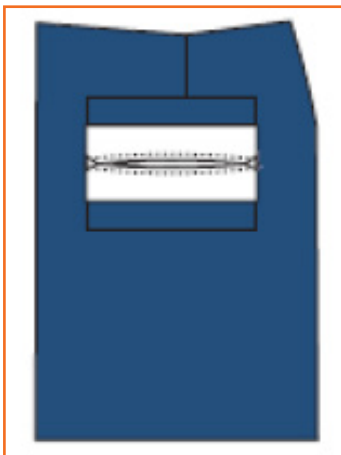

Step 9: Put 6 mm seam from the side-seam side towards the back rise side.

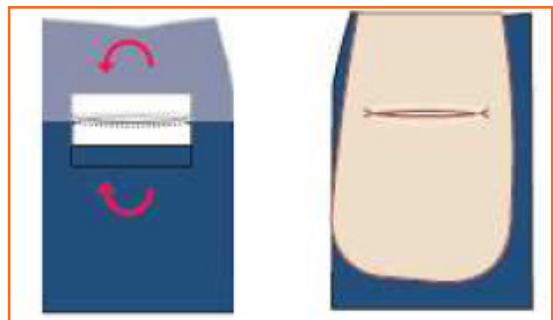

Step 10: Cut the fabric between the two bones leaving 10–12 mm on both sides.



Step 11: Put a slash on the edge of the folded pocket bag to the side.

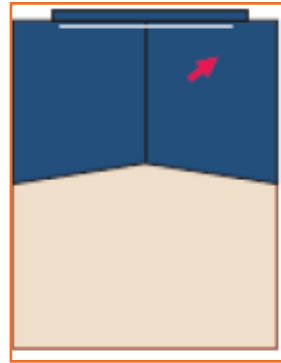

Step 12: Repeat steps 10 and 11 for the other bone.

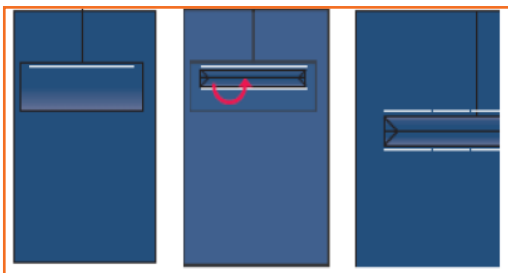

Step 13: Push the balance fabric inside.

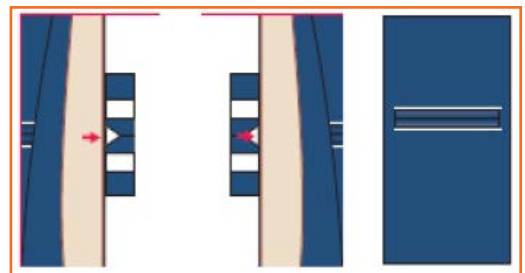

Step 14: Put a slash at the end of the cut.

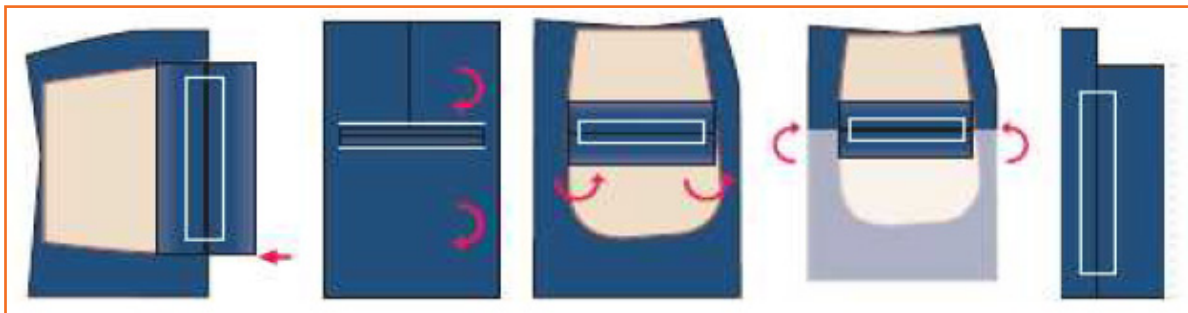

Step 15: Put overlock slash on the pocket bag from bone piece.



Step 16: Attach bone piece with the pocket bag using overlock slash.

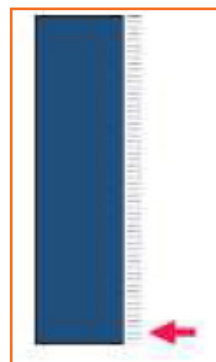

Step 17: Put overlock slash on the back pocket facing.

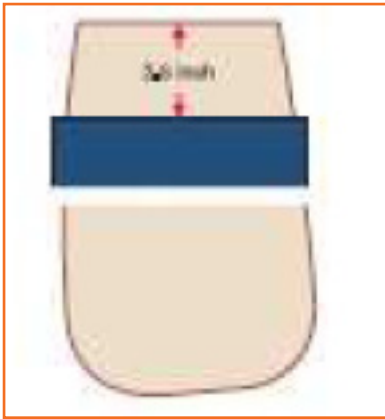

Step 18: Take the other piece of the pocket bag. Place the back pocket facing on top of the pocket bag at a distance of 2½ inches from top of the pocket bag.

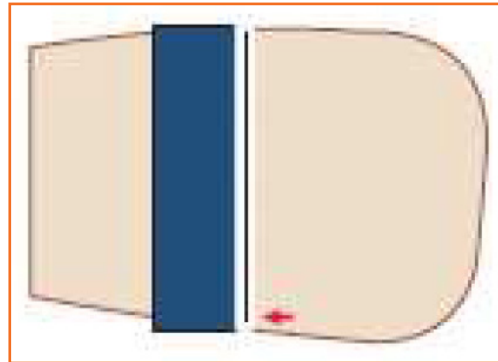

Step 19: Put a lockstitch over the overlock

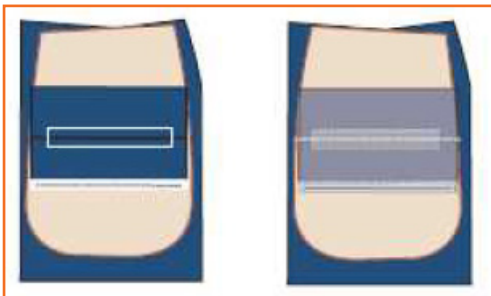

Step 20: Take the first pocket bag, which is already sewn to the back piece. Place the other pocket bag over it. Both the bags should match perfectly.

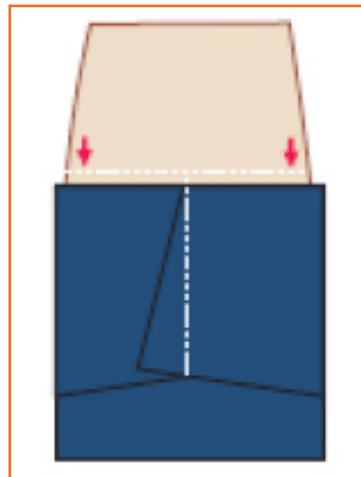

Step 21: Now put a lockstitch at the inner side to join the two pocket bags together.

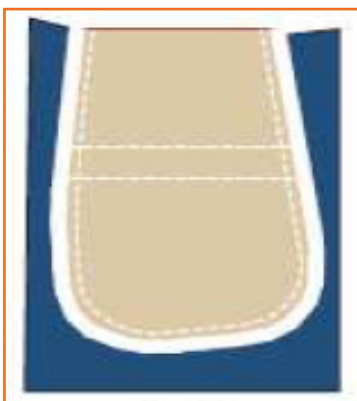

Step 22: Put 5-thread overlock stitches from right (back rise side) to the left side.

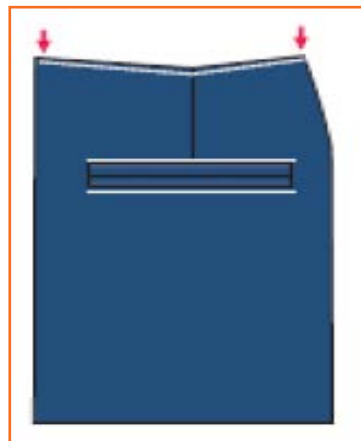

Step 23: Put 3 mm lockstitch at the waistline, starting from the left towards the right, to stitch the loose top end of the pocket bag with the fabric.

Fly Making and Attaching

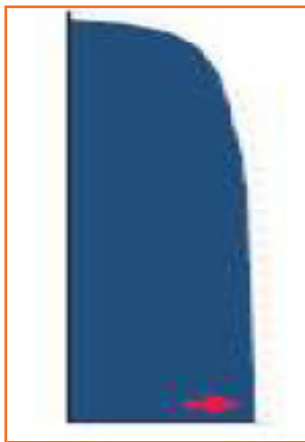

Step 1: Take the fused J- y piece and put overlock s ch on the face side of the fabric st rict from om of the curv op.

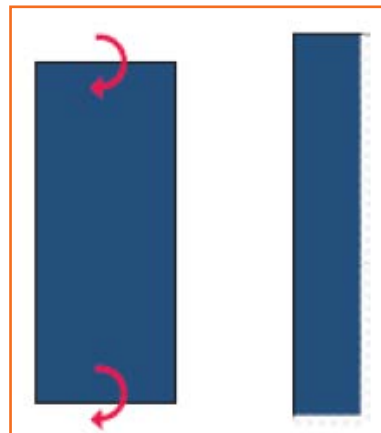

Step 2: Take the y sup e part. Fold it into two equal parts and put over lock s ch on the long open side and one on the short open sides.

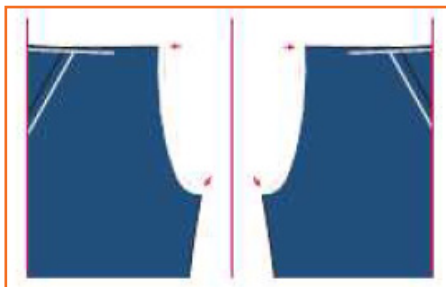

Step 3: Take the fused J- y piece and put overlock s ch on the face side of the fabric st rict from om of the curv op.



Step 4: Take the le front piece and place the J- y piece over the le front piece. Align the straight end of the J- y with the front rise along with the backside of the J- acing up.



Step 5: Put a 6 mm locks ch st rict from the om to the top (waist line).



Step 6: Turn the J- y piece and put an edge s ch on top of the y from om to top. Make sure that the raw edges are facing toward .

Zipper Attaching



Step 1: Take the zipper, open it and bring the slider down.



Step 2: Place the zipper with slider facing down over the piece at 8 mm from the straight edge at the top and 6 mm at the bottom. Align the bottom edge of the zipper with the curved



Step 3: Put an edge stitch on the left side of the zipper from top to bottom.

Step 4: Close the zipper and turn the piece 180 degrees clockwise.

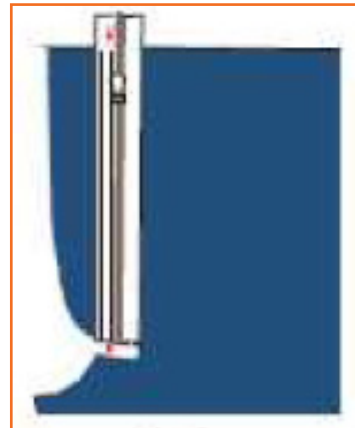

Step 5: Now put a 4 mm edge stitch from bottom to top.



Step 6: Take the top part. Place the zipper with slider facing up on the top part. Properly align the zipper end and the overlock side of the top part.

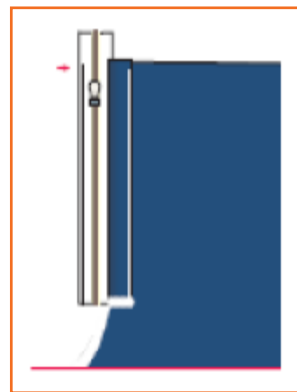

Step 7: Turn the fabric and put edge stitch on the zipper side from bottom to top.



Step 8: Take the right front piece and place the front rise side over the zipper. Make sure that the waistlines of both the left and right front pieces match.



Step 9: Put 6 mm seam allowance from the top to the top.



Step 10: Turn the stitched panels and bring the face side up.



Step 11: Leave a gap of 1 mm between the zipper teeth and the edge of the fabric and put top-stitch.



Step 12: Open the zipper.



Step 13: Turn the left side front piece from the zipper side at the point of stitching.

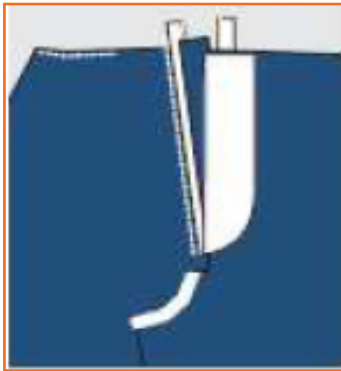

Step 14: Place the ready pattern of J- over the left front piece on the front rise side.



Step 15: Put locks along the ready pattern from top to bottom.

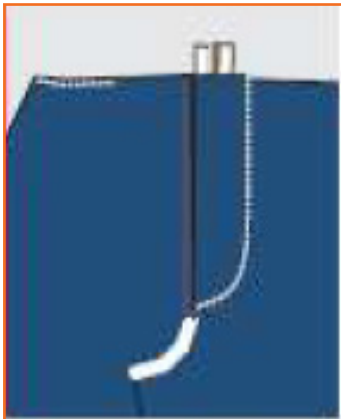

Step 16: Close the zipper and complete the J-stitch along the J-pattern.



Step 17: Put a top-stitch on the edge of the finished J-piece starting from bottom to top.

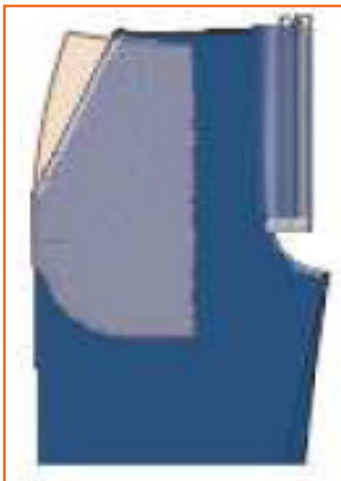

Step 18: Reverse the fabric and put 6 mm seam on the curve of the front rise.



Step 19: Turn the piece so that the front side of the fabric is facing up. Put an edge seam on front rise starting from bottom to top.

Back Rise Assembling



Step 1: Take both the left and right back pieces. Match them face-to-face.



Step 2: Put 1 cm seam at the back rise starting from top to bottom with back tuck at both the top and bottom.



Step 3: Now put overlock stitches at the back rise starting from top to bottom.

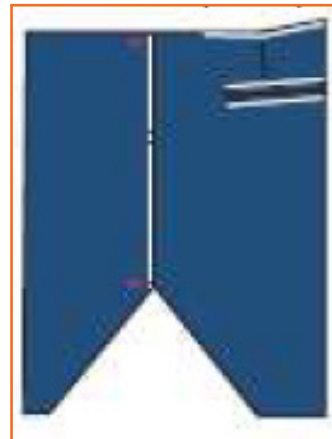

Step 4: Turn the raw edges towards the left side and put top-stitch at the edge of the back rise.

Front and Back Piece Assembling



Step 1: Place front and back pieces in such a way that the face sides of both pieces face each other.



Step 2: Put 1 cm seam throughout the right side starting from top to bottom.



Step 3: Turn the raw edges towards the back. Put top stitches at the edge from top to bottom for the right side and bottom to top for the left.



Step 4: Align the back and front rise seams and the open sides of the front and back.



Step 3: Put 5-thread overlock stitches from bottom to top at other side.

Belt Loop Making

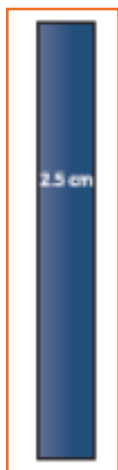

Step 1: Take a long strap, 2.5 mm wide, of the fabric used in body.



Step 2: Turn the raw edges towards the left side and put topstitch at the edge of the back rise.

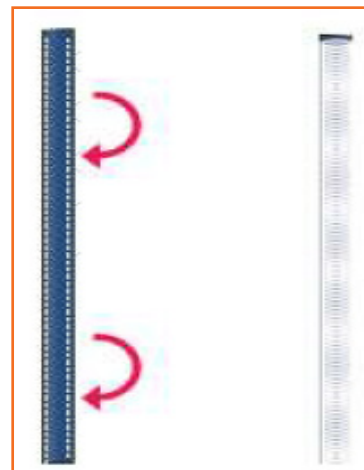

Step 3: Start sewing and feeding the fabric properly.

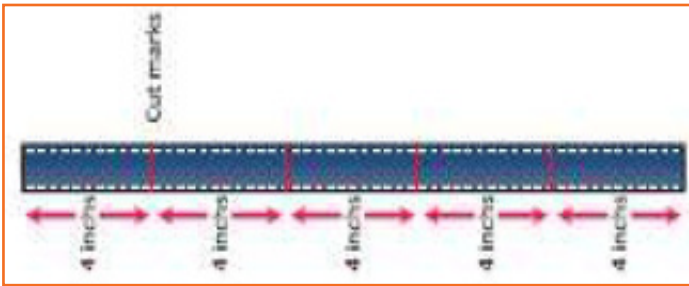

Step 4: Put the marking on the strap for the required length.

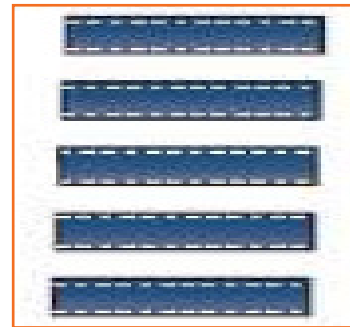

Step 5: Cut the strap of desired length.

Belt Loop Attachment

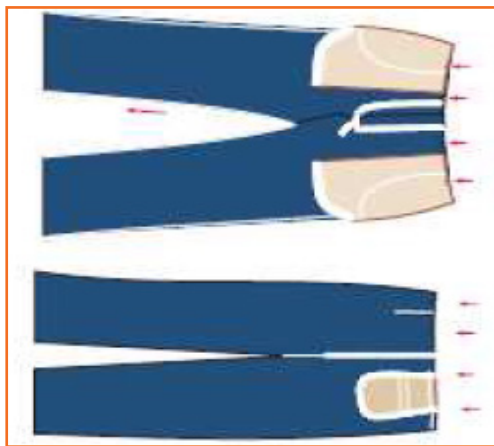

Step 1: Mark the waistline where the loops are to be attached.



Step 2: Place the belt piece, with the folded side up on the backside of the right front. Belt band should be extended by $\frac{1}{2}$ inch.

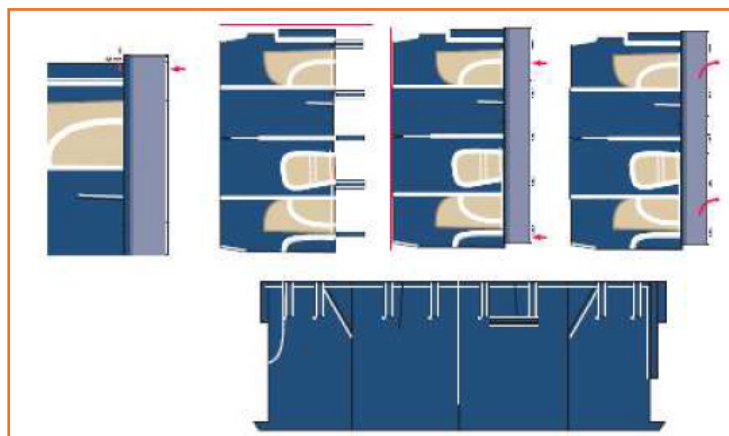

Step 3:

- Put a lock stitch adjacent to the folded part of the belt piece.
- Place the loop with the side facing the fabric and connect the end by placing other loops at required

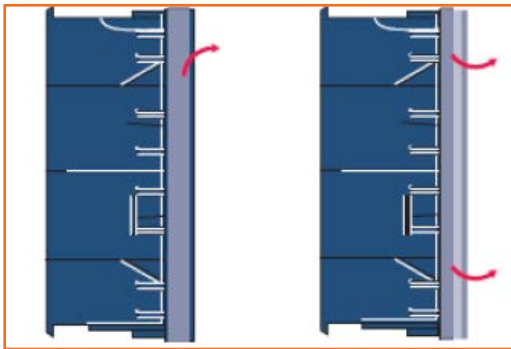

Step 4: Turn the belt piece in such a way that the fused side is up.

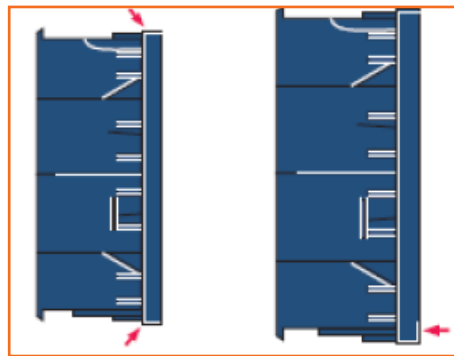

Step 5:

- Turn the open vertical end on both sides starting with back tack.
- Now again turn the belt piece so that the face side is facing up.

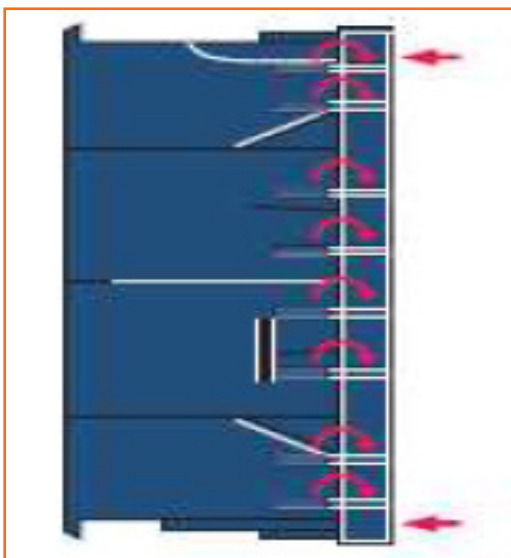

Step 6: Now put edge stitches throughout the length from the bottom side.

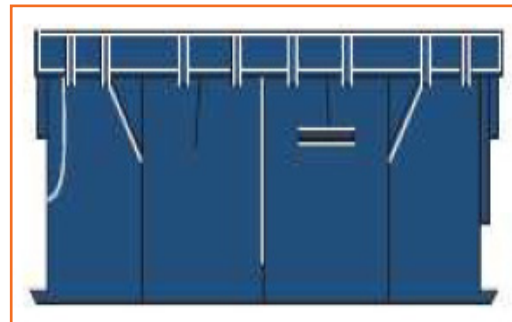

Step 7: Finally put edge stitches throughout the top side of the belt and stretch the loops at appropriate places.

Bottom Hemming

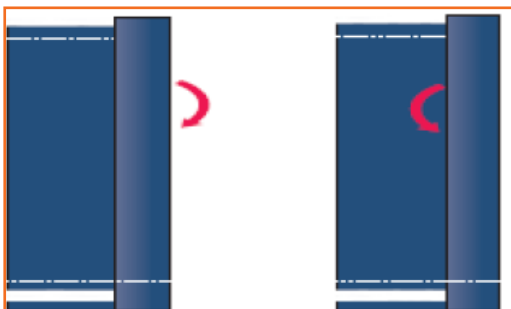

Step 1: Fold the fabric as per the design requirement.

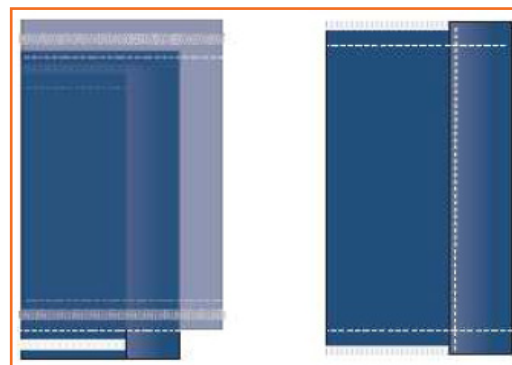

Step 2: Start stitching the edge stitch from the inseam and finish at inseam. Repeat steps 1 and 2 for the other leg.

Bottom Hemming Using Folder



- Step 1:** Fold the bottom of right trouser leg 1 cm inside. Again fold the fabric to the required width and put 2 or 3 stitches.
- Step 2:** Place the attachment in such a way that the folded fabric is inserted into the groove of the folder and then start stitching. Feed the fabric properly.
- Step 3:** Repeat steps 1 and 2 for the other leg.

Bottom Holeing

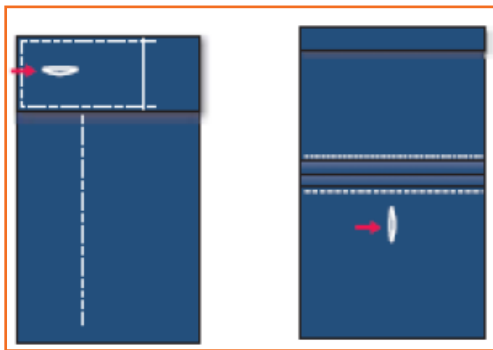

- Step 1:** Make the bottom hole on the left hand side belt as per design requirement. Make another bottom hole on the back pocket.

Bottom Attachment

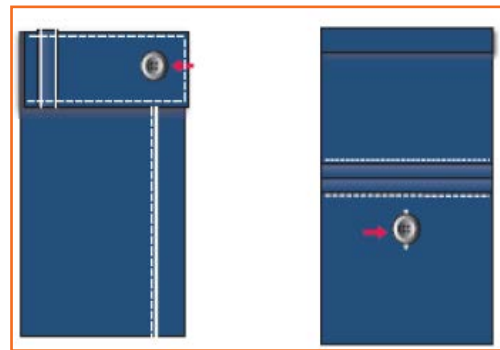

- Step 1:** Sew the button on the right hand side belt as per the design requirement and sew one button at the back pocket.

Bartacking

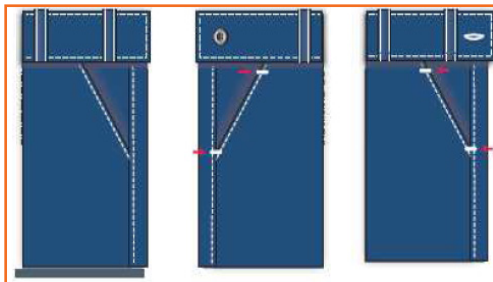

- Step 1:** Put bartack as per design requirement. Normally bartacks are put at both ends of left and right front pocket mouth and at the end of the front and back pocket joints.

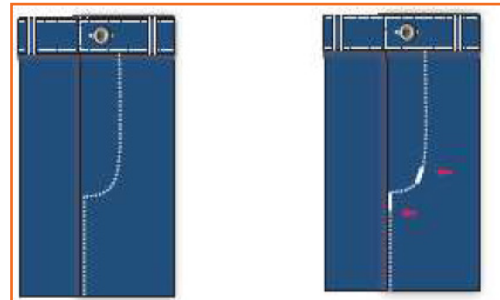

- Step 2:** Put the bartack at the end of the J- and at the curve of the J-.

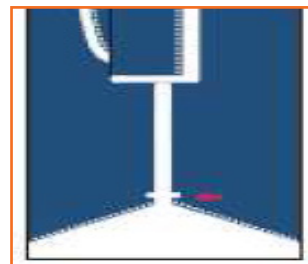

- Step 3:** Put the bartack at the joining of front and back rise.

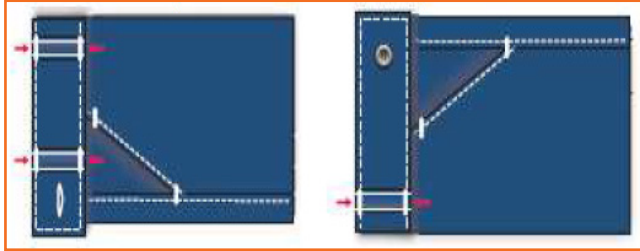

Step 4: Put the bartack at the top and bottom of each belt loop.

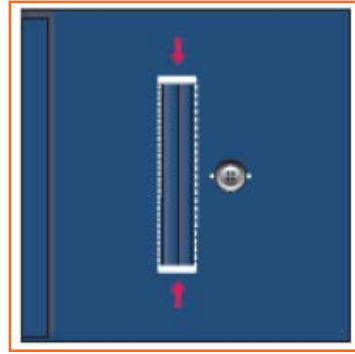

Step 5: Put the bartack at both ends of the back pocket.



Make the students understand and identify different parts of a trouser.

Identify the process of making and attaching the pocket, zip, back rise and front and back pieces to the pant.

Answer the questions students if they have any.

Notes for Facilitator



- Summarize the main points.
- Clarify doubts if they have any doubts.
- Encourage them to ask questions.
- Answer their queries satisfactorily.
- Try to complete the questions at the end of the unit.
- Ensure that everyone answers all the questions.

Suggest questions to ask students:

- Ask students to explain parts of a Trouser.

(Suggestive Note) As per students give practical questions our choice to understand the student's outcome.

Finishing a Shirt



At the end of this unit, the students will be able to:

1. Recognize different parts of a shirt.
2. Finish a shirt.

Resources to be Used

- Available objects such as black or white Board, chalk pieces or white board marker pens, duster
- PC with LCD Projector or Flip Chart
- Copies of handouts, Participants Handbook



- Do**
- Greet and welcome participants to the next session of the program.
 - Before starting, ask participants if they have any doubts pertaining to the previous unit.
 - Capture their responses on board and share them wherever necessary.
 - Tell them that they will learn about Finishing Department Work.

Elaborate

- Teach them how to make the left hand side placket.
- Demonstrate the process of making a pocket and stitching the same.
- Show them how to attach a yoke.
- Prepare the upper and lower sleeve placket preparation.
- Show them how to attach the sleeves and the side beams.
- Show them the process of making collar bands.
- Finally demonstrate the process of hemming.

Demonstrate 

Le

et 

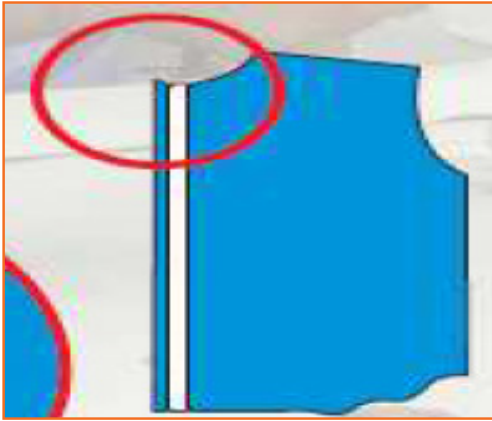

Step 1: Take the fused le et.

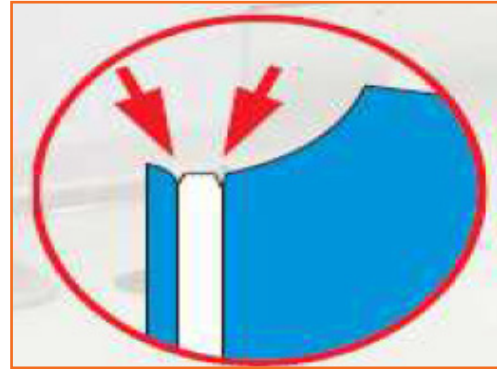

Step 2: Locate the two notch marks. There is one at 1.5 cm and the other at 5.5 cm from the edge.

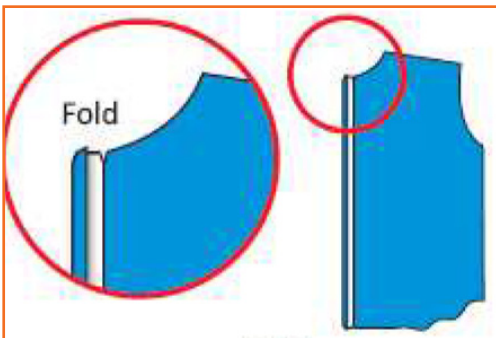

Step 3: Now, fold the fabric 1.5 cm the st notch mark and press the folded part with an iron.

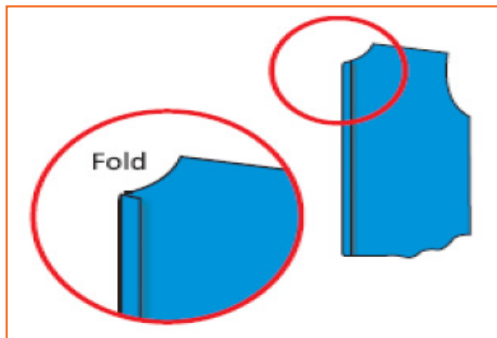

Step 4: Now, fold the fabric 4 cm to the second notch mark. The placket should be 4 cm wide.



Step 5: Now, crease the folded part again with an iron.

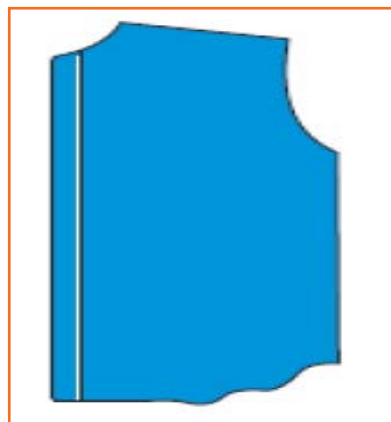

Step 6: Start from the bottom and stitch the inner side of the placket using edge stitch.



Step 7: Again from the bottom, stitch the outer side of the placket using edge stitch.

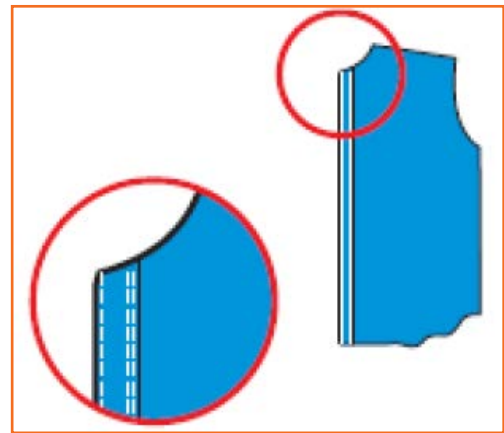

Step 8: Identify the reference mark on the throat plate and put a 4 mm seam allowance on the outer side of the placket from the bottom.

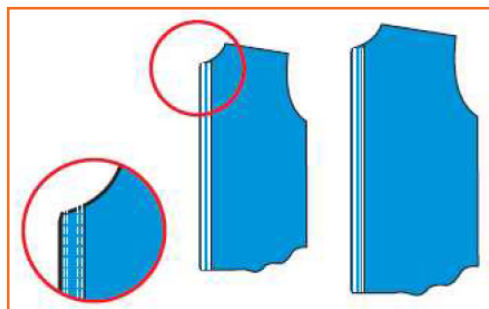

Step 9: Put a 4 mm seam allowance on the inner side of the placket from the top.

Right Hand Side Placket

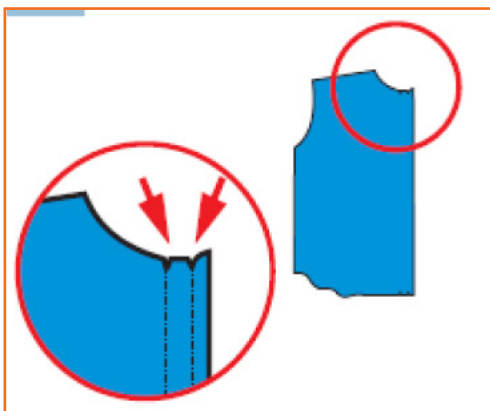

Step 1: Identify the notch marks on the back side of the fabric.

Step 2: Fold the fabric 1cm towards the notch mark or the neck, on the back of the fabric.

Step 3: Crease folded part.

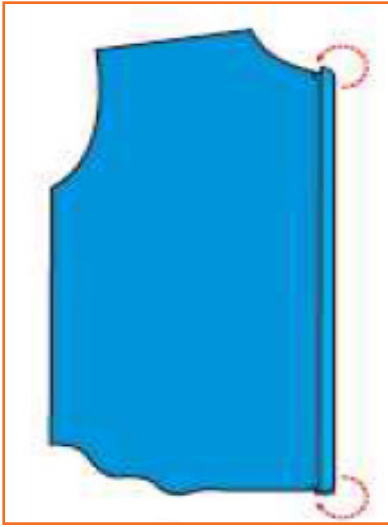

Step 4: Now, fold the fabric 2.5 cm the second notch mark.

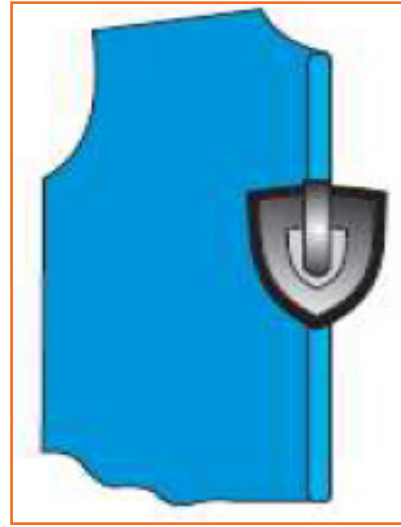

Step 5: Crease the fold with an iron again like in Step 3.

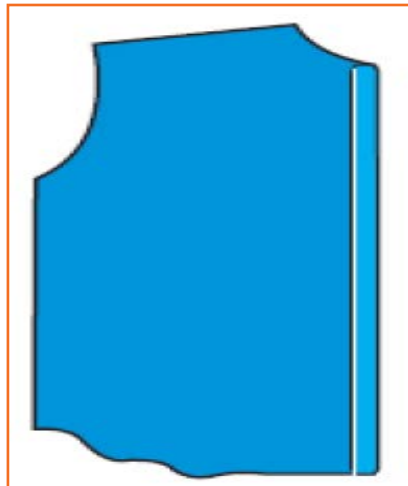

Step 6: Start from the top and stitch the inner side of the placket using an edge stitch.

Pocket

Stitching



Step 1: Take the fused pocket piece.

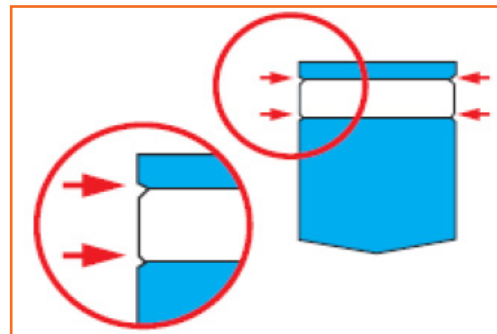

Step 2: Locate the notch marks.

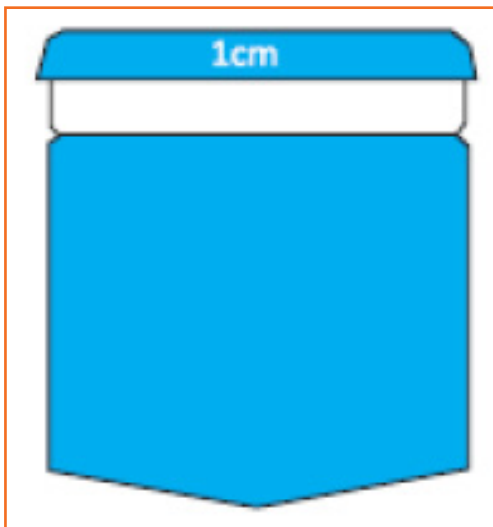

Step 3: Now, fold the top part of the fabric 1cm to the first notch mark and press the folded part with an iron.

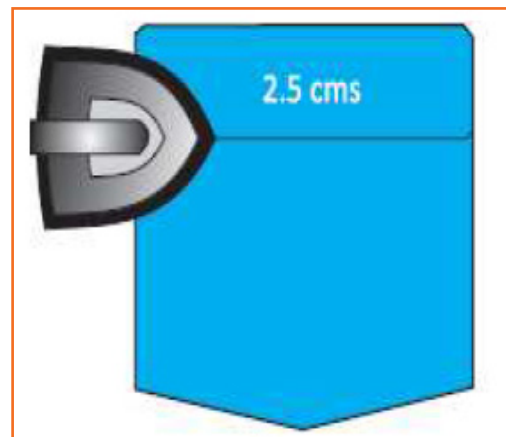

Step 4:

- Now, fold the fabric 2.5 cm to the second notch mark.
- Now, crease the folded part again with an iron.

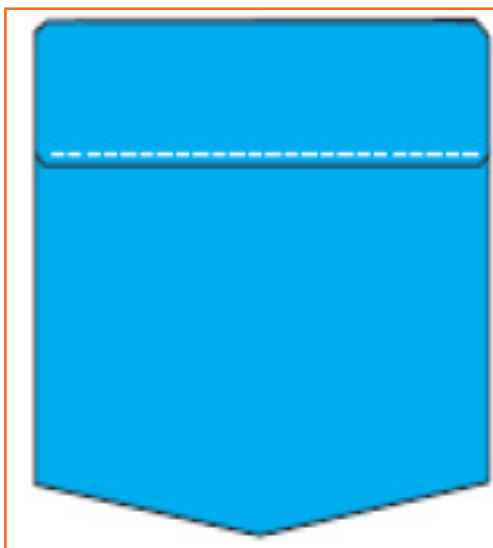

Step 5: Stitch the inner side of the pocket mouth using edge stitching.

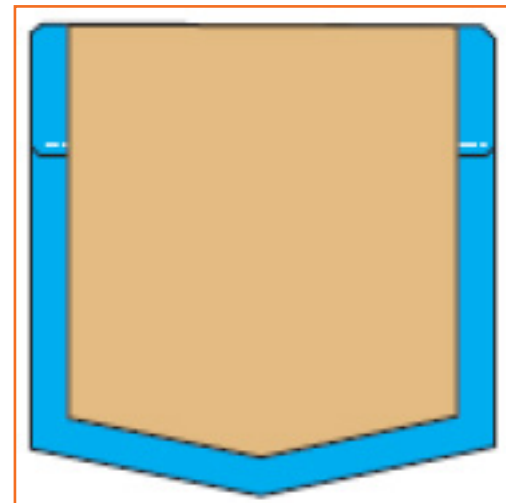

Step 6: Take the ready pattern given and place it over the pocket.

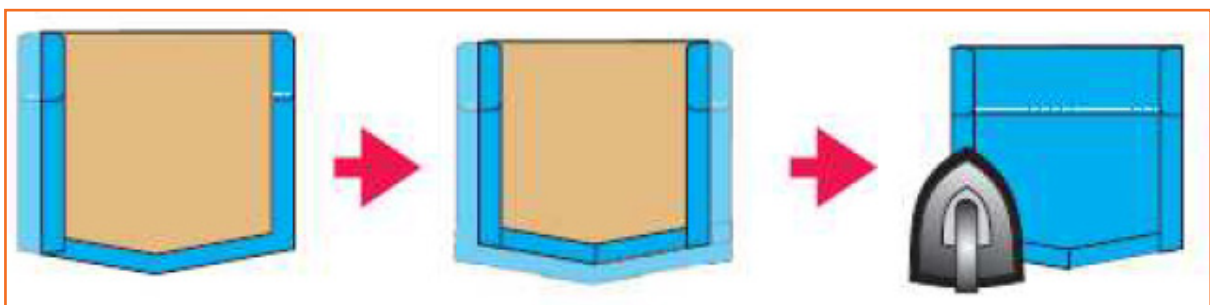

Step 7: Now, fold the three sides 1 cm each and crease them as you fold.

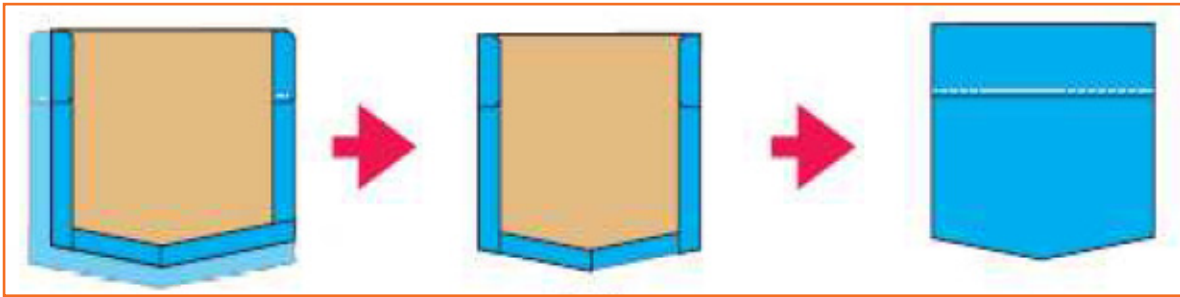

Step 9: The pocket is now ready to be attached.

Attaching the Pocket



Step 1: Place the pocket piece on the left half of the shirt front.

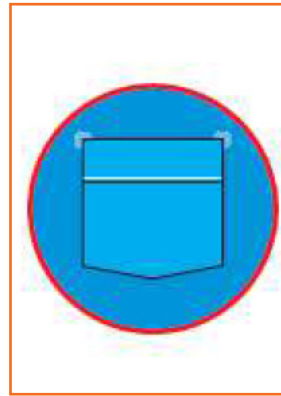

Step 2: Match the right side of the pocket with the markings on the front of the fabric.

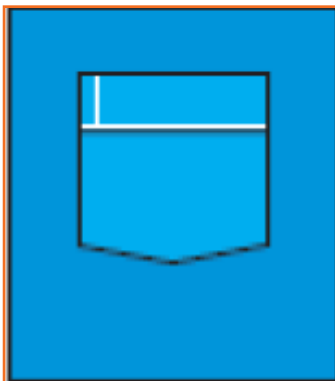

Step 3: Sew the pocket from the placket side. Put 4 stitches followed by a back tack.

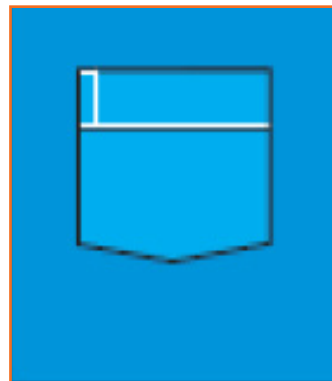

Step 4: Now, sew the top using 4 mm stitches.

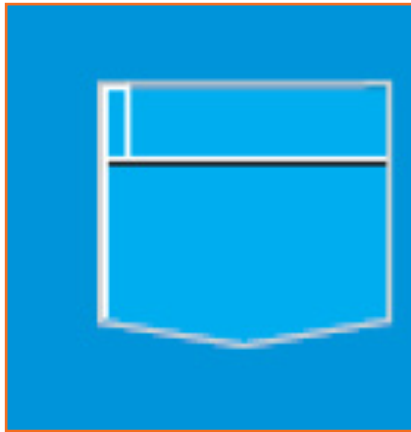

- Step 5:**
- Turn the fabric in a clockwise direction. Keep the needle in the fabric.
 - Sew at the edge of the pocket

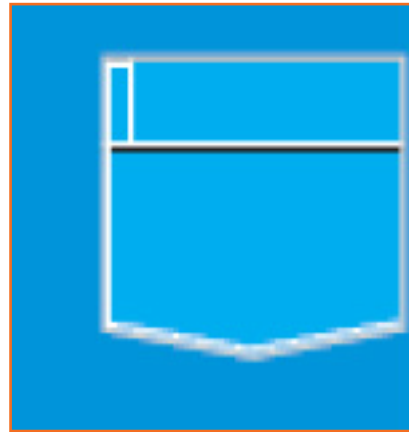

- Step 6:**
- Again, turn the fabric clockwise.
 - Put the needle at the edge of the end.

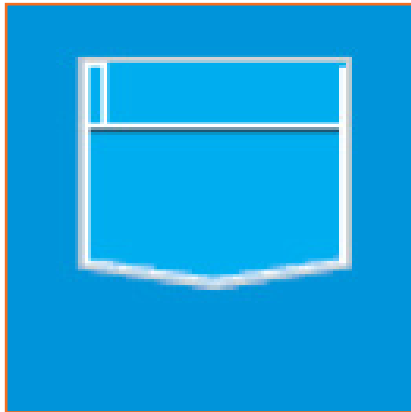

- Step 7:**
- Again, turn the fabric clockwise. Sew the edge of the top part of the pocket.
 - Step 10: Turn the fabric clockwise and sew the edge of the other side of the pocket.

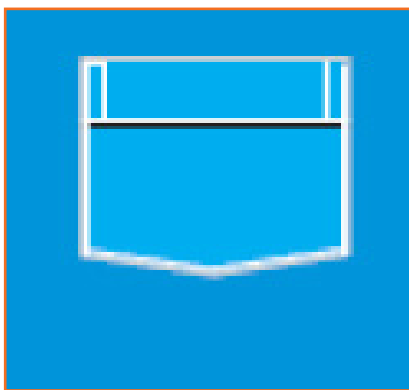

- Step 8:**
- Again, turn the fabric clockwise and sew up to 4 mm.
 - Turn the fabric. Sew up to the pocket mouth and put a back tack.

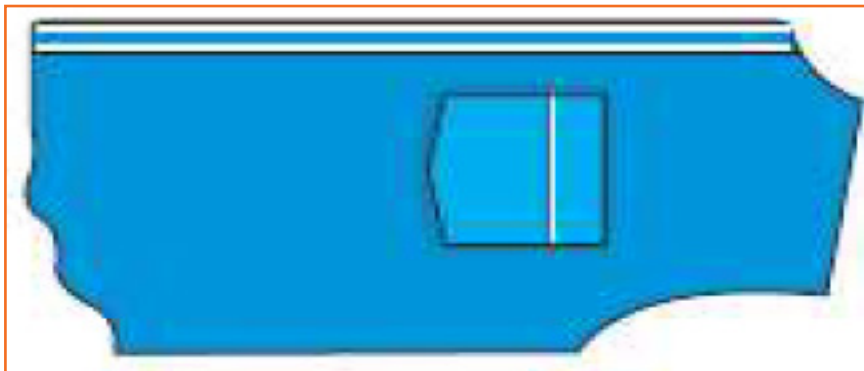

- Step 9:** Now, the pocket is fully finished.

A Matching Yoke

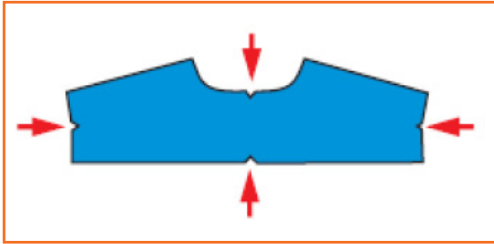

Step 1: First, check for the following notches:

- One notch at the centre of the back piece of the shirt.
- 4 notches in the yoke piece:
 - » One at the centre of the reverse side of the yoke piece.
 - » One at the centre of the neckline.
 - » One at the centre of the left armhole.
 - » One at the centre of the right armhole.

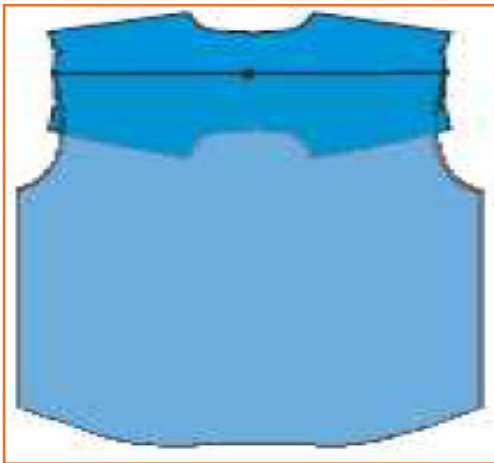

Step 4: The right side of the inner yoke piece should face the reverse side of the back piece of the shirt. Take the other yoke piece and place it on top of the back piece of the shirt and align with the notch.



Step 2: Keep one piece of the yoke on the sewing machine.



Step 3: Place the back piece of the shirt on top of the yoke in alignment with the two notches.

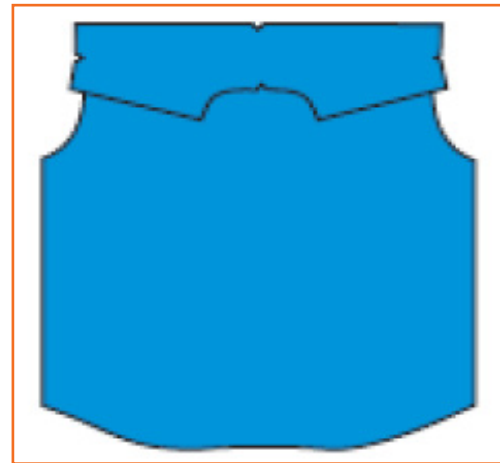

Step 5: The alignment should be such that the right side of the outer yoke piece faces the right side of the back piece of the shirt.

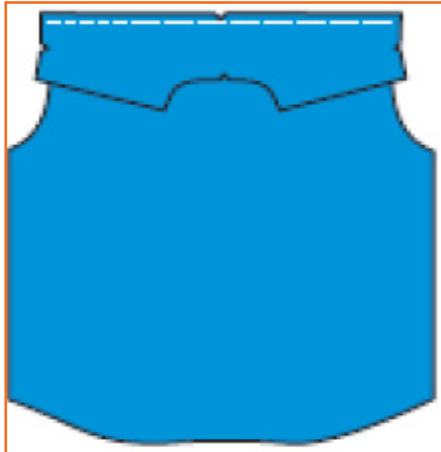

Step 6: Put a seam allowance of 1cm on the edge of the 3 pieces—2 yoke pieces and the back piece of the shirt.



Step 7: Turn the yoke and crease it with your fingers.

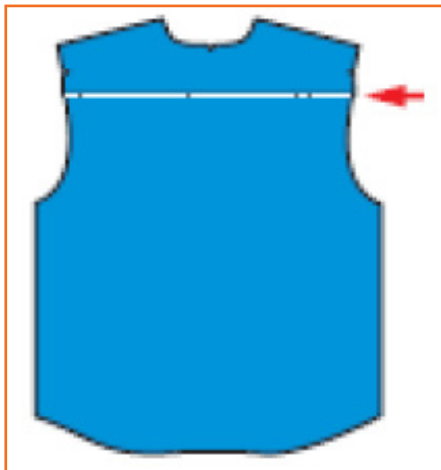

Step 8: Now, put a top seam allowance at the edge.

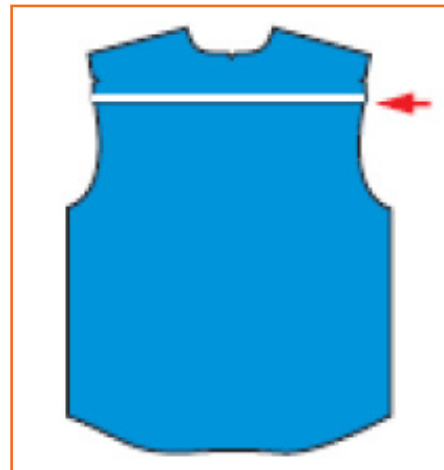

Step 9: Finally, put a 4 mm seam allowance from the edge.

Attaching Yoke to the Front



Step 1: Keep the front side of the back piece of the shirt on the top.

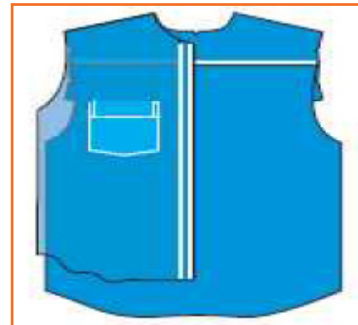

Step 2: The alignment should be such that the right side of the outer yoke piece faces the right side of the back piece of the shirt.



Step 3: The pieces are s ched at a distance of 1 cm from the edge leaving the om-most ply of the yoke.



Step 4:

- The right side of the front and the right side of the back piece of the shirt are placed together by matching the yoke. The placket should be towards the centre.
- Repeat Step 3 for right side.



Step 5: Hold the edge of the yoke from the armhole side in one hand and the uns ched yoke piece in the other hand.



Step 6: Turn and match the uns ched yoke piece to the s ched yoke piece.

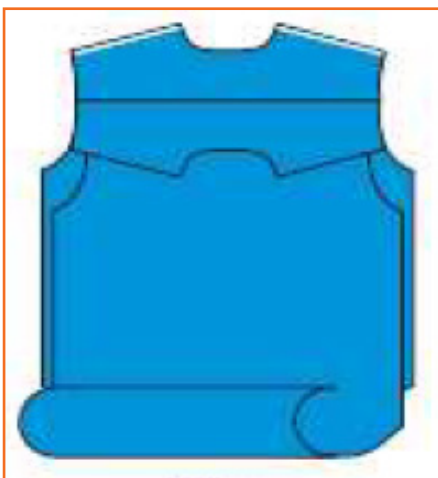

Step 7: Roll the body fabrics and insert it between the two yoke pieces.



Step 8: Put a 1 cm s ch throughout.

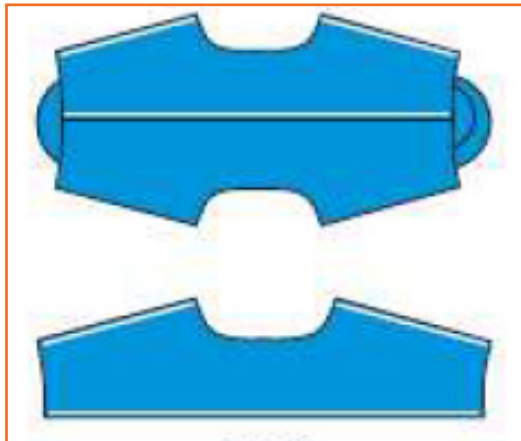

Step 9: Hold the front and the back pieces and stretch them.

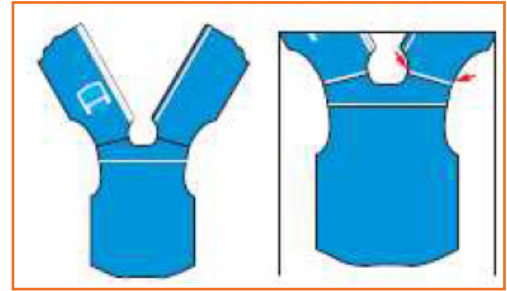

Step 10: Put a top-stitch at the edge on both sides.



Step 11: Finally, put a 4 mm seam on both sides.

Upper Sleeve Placket Preparation

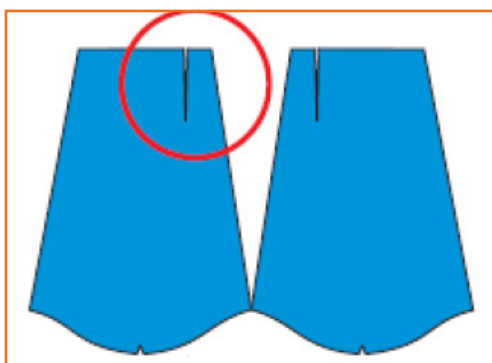

Step 1: Take the two sleeve pieces and identify the notch marks on the armhole side in each one of them.

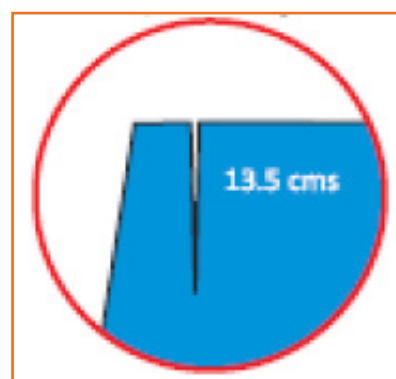

Step 2: Look at the reverse side of the sleeve and ensure that there is a cut of 13 cms or 5 inches approximately.



Step 3: Keep the two sleeve plackets with their straight sides facing each other.

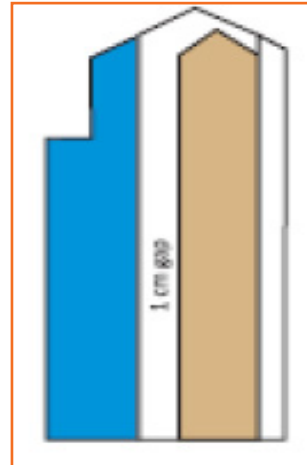

Step 4: Take the ready pattern. Leave a gap of 1 cm and place it over the longer side of the placket.

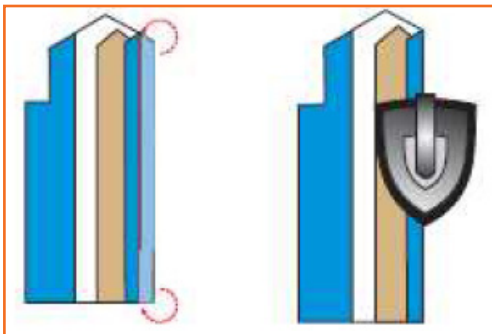

Step 5: Use the pattern and fold the longer side of the placket 1 cm and iron it.

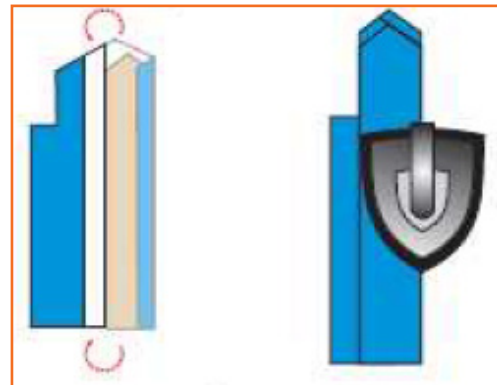

Step 6: Again, using the pattern, fold the longer side 3.5 cm and iron it.

Step 7: Use the pattern and fold the upper of the placket in a V-shape. Iron it well to form crease.

Step 8: Use the pattern and fold the upper of the placket in a V-shape. Iron it well to form crease.

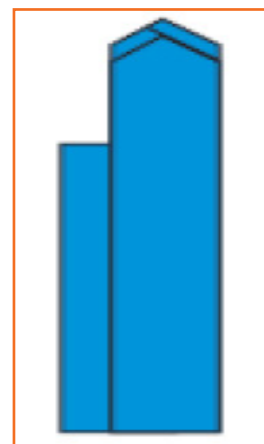

Lower Sleeve Placket Preparation



Step 1: Keep both the lower sleeve plackets on the Fig.

They are unfused and shorten in length than upper sleeve plackets.

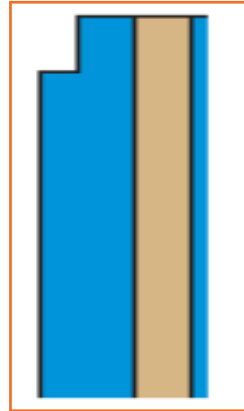

Step 2: Place the ready pattern on the placket.



Step 3: Use the pattern and fold 1 cm. Use the iron to crease it.

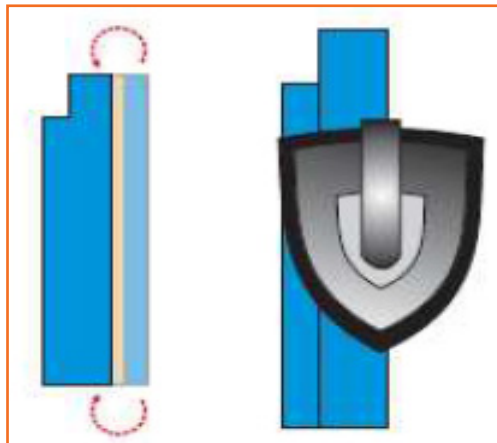

Step 4: Again, use the pattern and fold 2 cm. Use the iron to crease it.

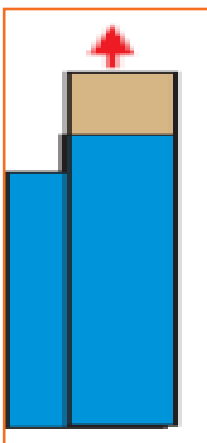

Step 5: Remove the ready pattern.

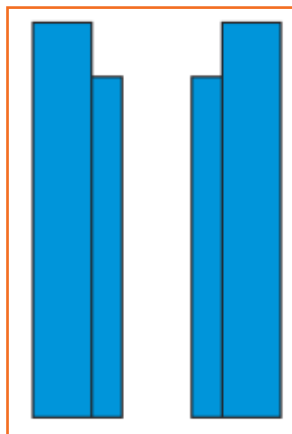

Step 6: Repeat Steps 2 to 5 for the other placket.

Attaching Plackets to the Sleeve



Step 1: Place the two sleeves on top of each other and align the cut sides.

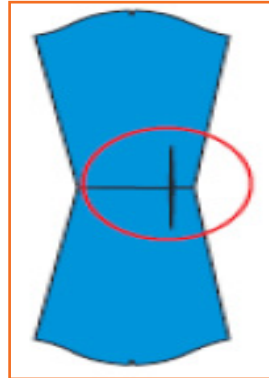

Step 2: Take the two upper sleeve plackets and place them on the longer cut side of the sleeves. Ensure that the folded side is on top.

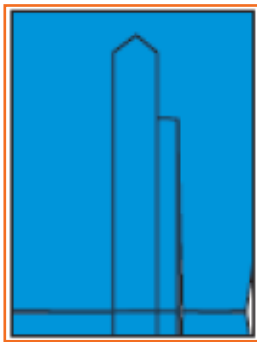

Step 3: Take a set of sleeve placket and sleeve. Align the edges of the sleeve placket with the longer cut part of the sleeve.

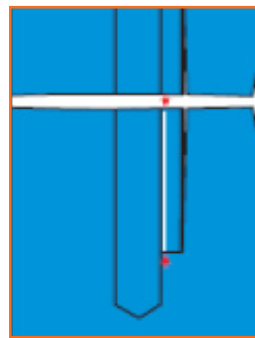

Step 4: Match the placket edge. Take the other set of sleeve and sleeve placket. Match the placket edge.

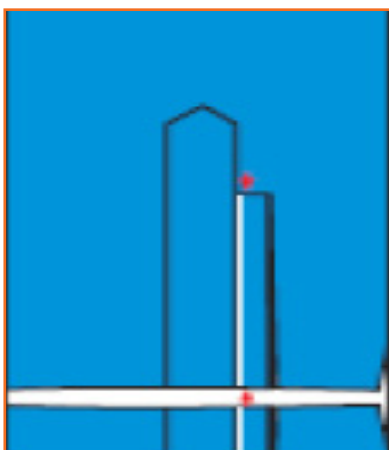

Step 5: Turn the fabric such that the cut part of it faces you.



Step 6: Now, place the lower placket on the shorter cut part of the fabric and match the edge along the length. Repeat Step 3 and Step 6 for the other set of sleeve plackets and sleeves.

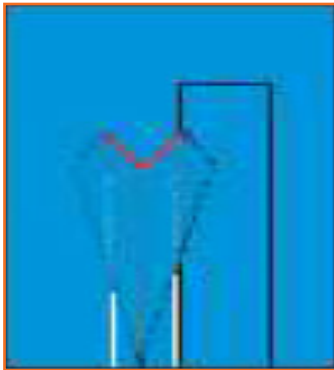

Step 7: Make two v-shape cuts on the top part of the placket-strip.

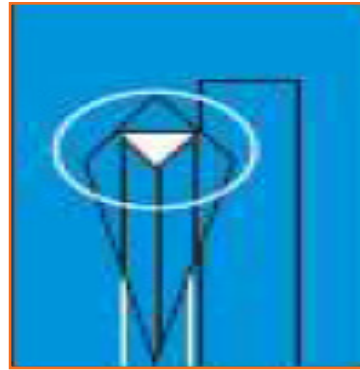

Step 8:

- Smoothen the lower placket and turn it to the reverse side.
- Finish the edged side of the lower placket
- Turn the v-shaped cut to the upper side.

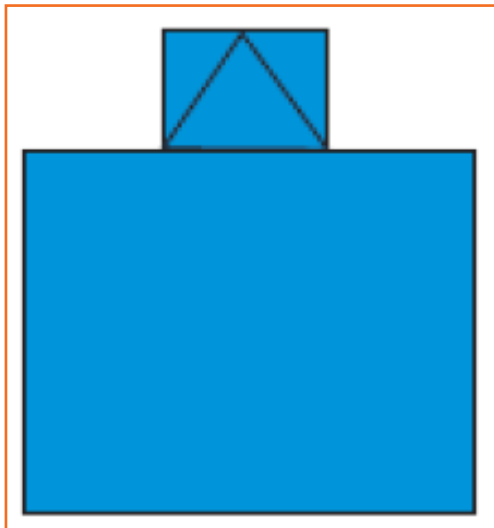

Step 9: Place the placket on top of the v-shaped cut.

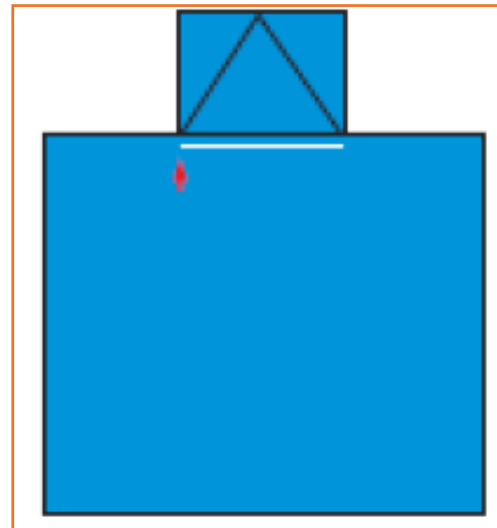

Step 10: Hold the placket and the cut, together and put a stitch at the bottom of the cut.

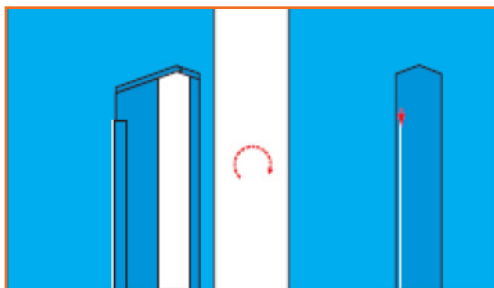

Step 11:

- Turn the upper placket over and put an edged side
- Turn the fabric clockwise. Align the upper and lower plackets.

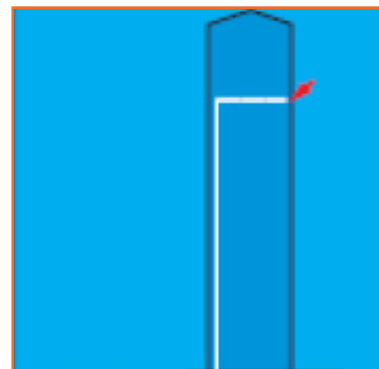

Step 12: etc.

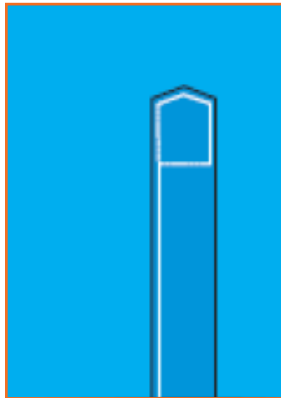

- Step 13:**
- Turn the fabric counter-clockwise. Put an edge stitch on all the edges of the box of the placket.
 - Repeat Step 9 to Steps 7-13 for the other sleeve plackets.

Attaching the Sleeve

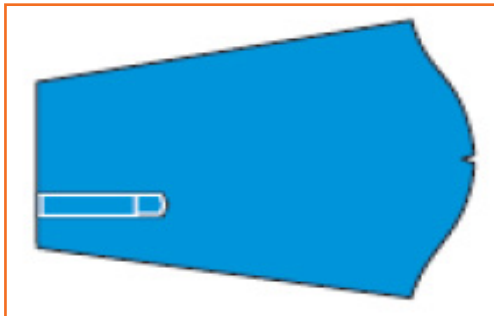

- Step 1:** Take the sleeve piece. Ensure the armhole faces you. Also, the longer cut edge should be on the right hand side. The sleeve should be attached to the left

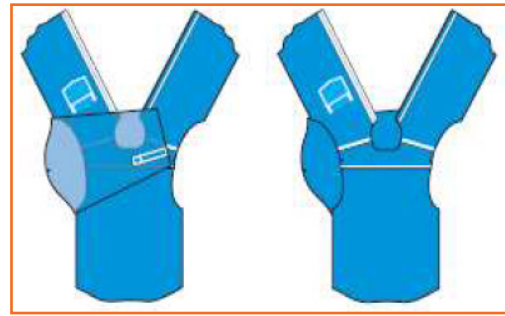

- Step 2:** Match the left front piece with the armhole. Place the shirt front above and the sleeve piece below.



- Step 3:** Attach the left front with the left sleeve with a 1 cm stitch.



- Step 4:** Take the right sleeve and place it on the machine. Ensure that the longer cut edge is to the left and facing away from you.



Step 5: Match the notch marks and attach the sleeve armhole with the body armhole.



Step 6: Put an over-lock stitch at both the armholes. If top-stitch is required on the armhole, the sleeve should be kept up and the body part of the shirt should be kept down while stitching the over-lock stitch. In case top-stitch is not required, the body part of the shirt should be kept up and the sleeve down.

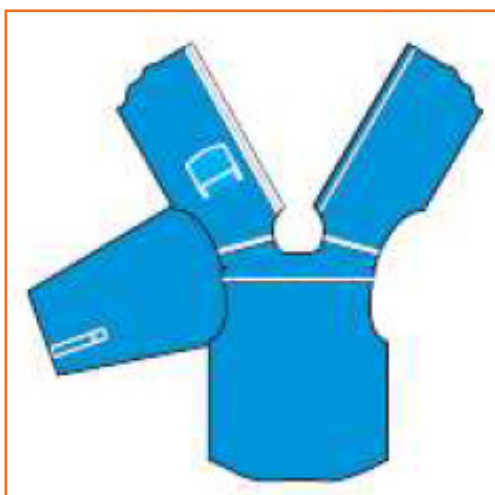

Step 13:

- While putting top-stitch, keep the margin towards the body. Put an edge stitch followed by a 4 mm top-stitch.
- Repeat the above steps for the other sleeve piece.

Side Seam

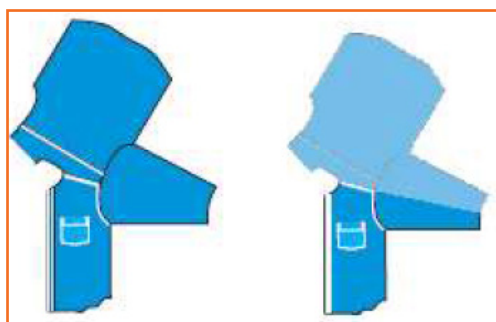

Step 1: Match the armhole and align the loose ends.

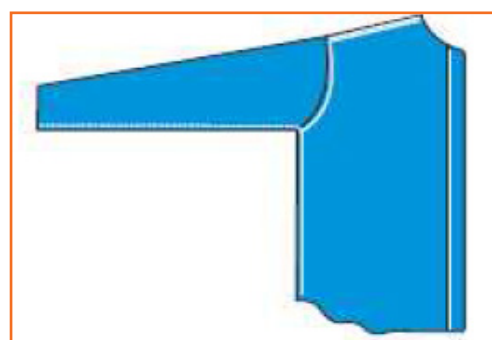

Step 2: Take the right hand sleeve. Stitch 1 cm from the sleeve seam and continue.

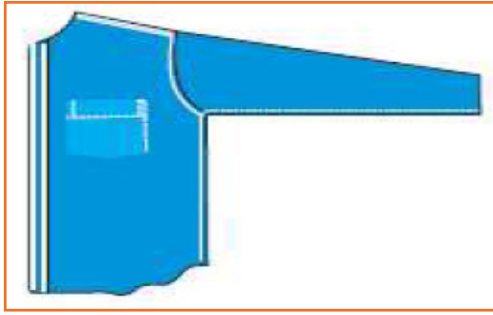

Step 3: Take the left hand sleeve. Cut 1 cm from the seam allowance up to the sleeve seam.

- Turn the fabric margin towards back side and sew the top seam by first sewing edge seam and then 4 mm seams on both the sides.

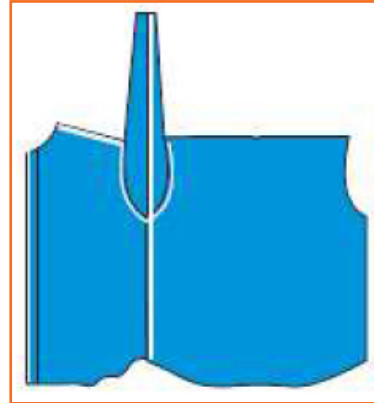

Step 4: Put the overlock stitch on both sides, keeping the front part on the top.

Collar and Neckband Preparation

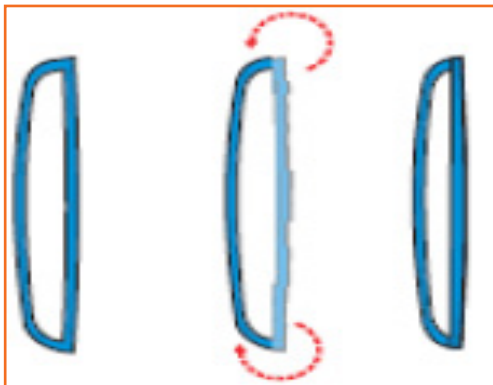

Step 1: Take the fused neckband piece. Turn the right side of the piece with your hand.

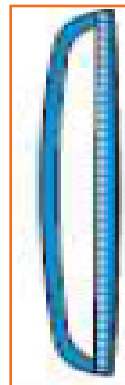

Step 2: Turn the fusing side down. Put a 4 mm seam at the top.

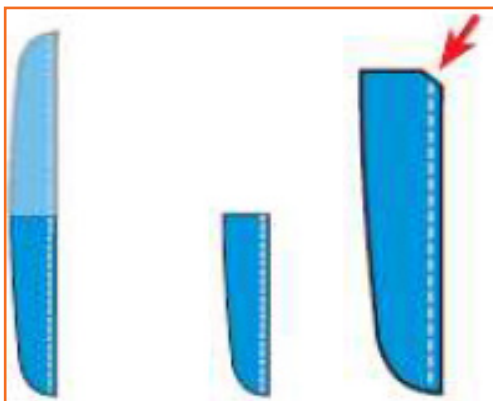

Step 3: Fold the neckband and cut a notch at the centre of the upper side.

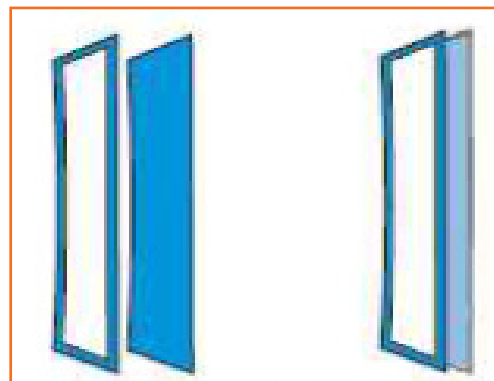

Step 4: Take the fused collar piece and place it on the collar piece that is not fused. The right side of the fused collar should face the right side of the unfused collar.

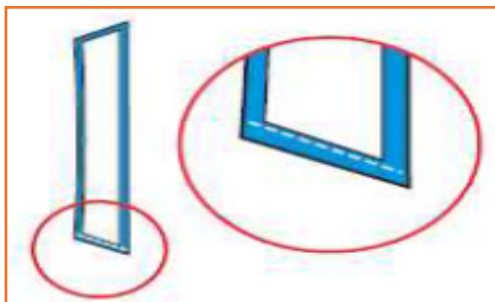

Step 5: Start sewing at a gap of 1 mm from the fusing material from the collar base side.

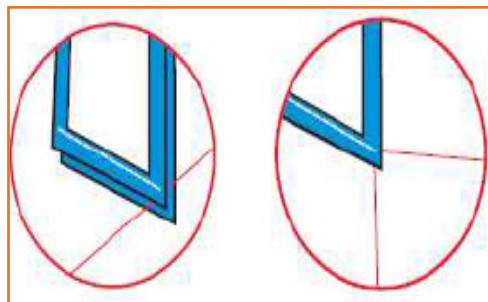

Step 6: Stop the sewing machine one stitch before the collar point with the needle down. Insert an extra thread between the two fabric layers touching the needle.



Step 7:

- Put one stitch and stop the sewing machine with the needle down. The thread will be at the back of the needle side.
- Hold both ends of the thread and bring it towards the other side of the collar.
- Put stitches at a distance of 1mm from the fused material on the remaining collar.
- Repeat steps 6, 7, 8, and 9.

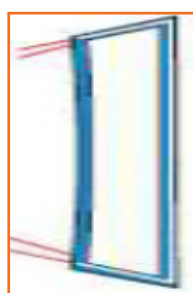

Step 8: Now, put stitches at a distance of 1 mm from the fused material.

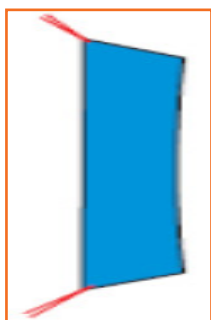

Step 9:

- Put back tack stitch at both the ends.
- Cut both the collar points and turn the collar.
- Stretch the threads to give proper shape to the collar.

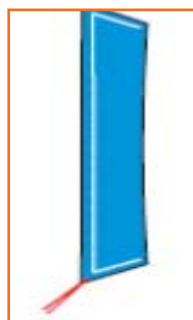

Step 10: Put a 4 mm stitch on all three sides of the collar. Keep the lower fabric stretched to avoid wrinkles.



Step 11: Put the seam just below the fused

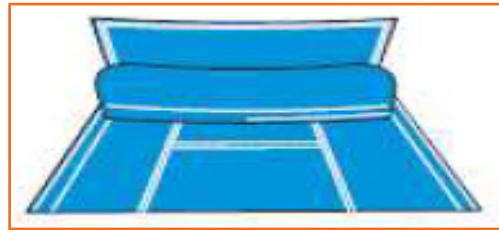

Step 12: Start from the neckband's centre, put edge seam towards the right side.



Step 13: Turn and continue to put edge seam

epara

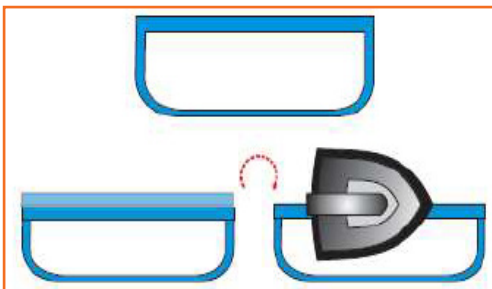

Step 1: Fold the fabric edges on the straight on it.

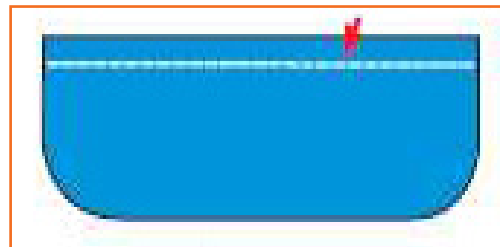

Step 2: Put a 4 mm top-stitch.



Step 3: Take the unfused piece of the and place it below



Step 4: stitch the two curved and one straight side by leaving a 1 mm gap.

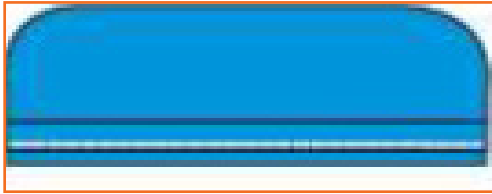

Step 5: T



Step 6: The unfused fabric should be 1 mm extra.

Attachment to Sleeve



Step 1: First, check that there are 4 notches for sleeve pleats and one notch at the centre of sleeve hem.

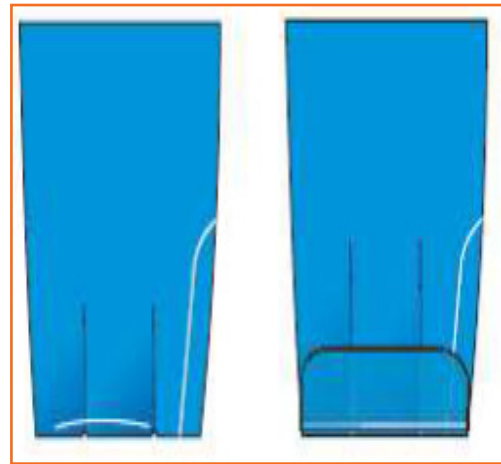

Step 2: Make sleeve pleats by overlapping the notches and stitching it in such a way that the pleats remain open from the edges.

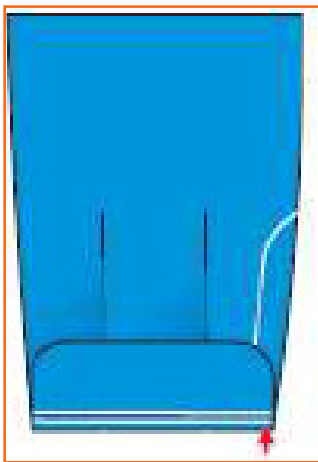

Step 3:

- Place the fabric with fused side up on the inner side of the sleeve.
- Stitch just below the edge of the

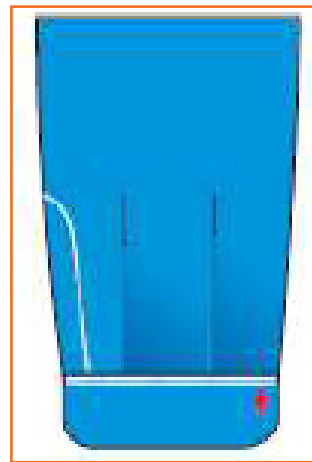

Step 4: Straighten the fabric inside the sleeve. Put the excess fabric inside and put stitches at the edge.



Step 5: Now put the edge stitch throughout the hem.



Step 6: Now put 4 mm stitch throughout the hem. Repeat Steps 1 to 7 for the second hem.

Collar Hemming



Step 1: Match the center of the collar to the center of the garment.



Step 2:

- Fold the collar (as per requirement) and put edge stitch from the left front side to the right side.
- Close the two ends.

Collar Button-holing

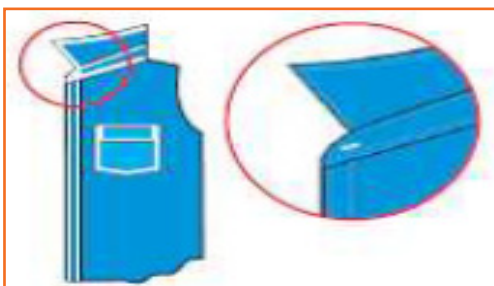

Step 1:

- Take the left side of the collar.
- Make one buttonhole on collar band parallel to the band at the centre and about 1 cm from the edge.



Step 2:

- Along the centre of the placket width, mark the buttonholes at a distance of 9 cm from each other from the collar band to the bottom hole.
- In case of a wide collar, mark a buttonhole at the centre of the collar band on the left side.
- Make buttonholes using a buttonhole machine. The marking should come in the middle of the buttonhole.

on A aching

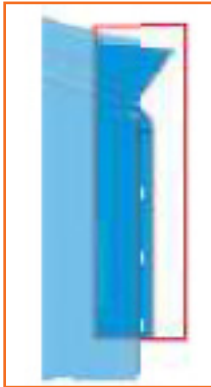

Step 1: Keep the left hand and right hand plackets on top of each other. They should be properly aligned.

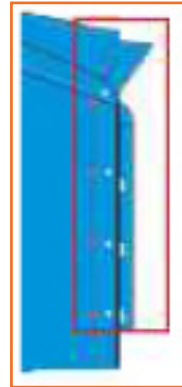

Step 2: Put a mark at the centre of the opening using a chalk.



Step 3: Attach buttons at the marked positions on sewing machine.



Step 4: Repeat the same procedure for the other side.



- Make the students recognize different parts of a shirt.
- Analyze how an SMO makes and attaches the left and right hand side placket, pocket, yoke, placket to sleeve, sleeve, side seam, collar, and hemming etc

Notes for Facilitator



- Summarize the main points.
- Ask students if they have any doubts.
- Encourage them to ask questions.
- Answer their queries satisfactorily.
- Try to complete the questions at the end of the unit.
- Ensure that every student answers all the questions.

(Suggestion Note) As per student give practical questions our choice to understand the student's outcome.



Skill India
कौशल भारत - कुशल भारत



सत्यमेव जयते
GOVERNMENT OF INDIA
MINISTRY OF SKILL DEVELOPMENT
& ENTREPRENEURSHIP



N · S · D · C
National
Skill Development
Corporation

Transforming the skill landscape



APPAREL MADE-UPS HOME FURNISHING
SECTOR SKILL COUNCIL

3. Contribute to Achieve Product ching Opera

Unit 3.1 - Contribute to Achieve Pr

ching Opera

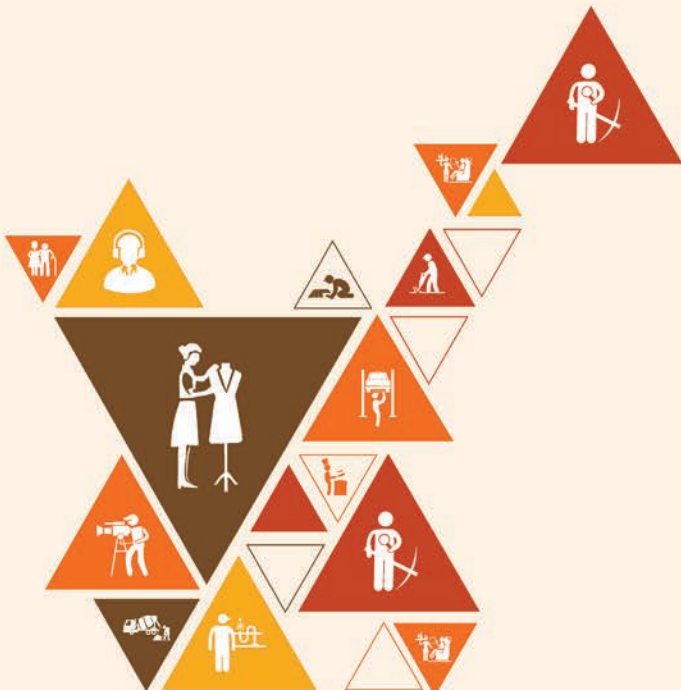

AMH/N0302

Key Learning Outcomes

At the end of this module, you will be able to:

1. Coordinate with the product quality
2. Coordinate with seniors and others.
3. Understand the sewing pr w.
4. Learn about the pr ystem.
5. Inspect s ched products agains a
6. Iden y, mark and place rejects in the designated loca
7. Carry out altera
8. Sew and apply trims by hand and machine.
9. Maintain w w and meet pr arget.
10. Familiarize with the quality department and its role in pr
11. Underst fects.

UNIT: 3.1 Contribute to Achieve Pr

ching Opera



At the end of this module, the students should be able to:

1. Coordinate with the product quality
2. Coordinate with seniors and others.
3. Understand the sewing pr w.
4. Learn about the pr ystem.
5. Inspect s ched products agains a
6. Iden y, mark and place rejects in the designated loca
7. Carry out altera
8. Sew and apply trims by hand and machine.
9. Maintain w w and meet pr arget.
10. Familiarize with the quality department and its role in pr
11. Underst facts.

Resources to be Used 

- Available objects such as black or white Board, chalk pieces or white board marker pens, duster
- PC with LCD Projector or Flip Chart
- Copies of handouts, P ts Handbook

Do 

- Greet and welc ts to the next session of the program.
- Before st y have any doubts pertaining to the previous unit.
- Capture their responses on board and share them wherever necessary.
- Tell them that they will learn about Finishing Department W w

Elaborate



- Explain to the students what is meant by the term product quality.
- Give them brief about ensuring them how to give the best products a
- Explain the necessity of coordina s when they are working as a team.
- Demonstrate the sewing process with step by step diagr w charts to the students.
- Demonstrate and show them that why necessary and what is should be done to ensure that the end product meets the pr a
- Explain the importance of examining garments at erent stages of pr and how does it help in a
- Give them appropriate w charts and tabular representa of various defects, their causes and their remedies.
- Explain them the av y realize that the product does not meet the requirements.
- Make them understand the importance of target achievement and what should be done to solve the same.
- Thoroughly explain them the plausible defects that might arise while s ching and the available for the same.



- Make the students learn about the pr ystem in the visit to the apparel manufacturing unit.
- Giv orks.
- Make them analyze the various things taught in the module on individual basis.

Notes for Facilita



- Summarize the main points.
- ts if they have any doubts.
- Encourage them to ask ques
- Answer their queries sa factorily.
- T ts to complete the ques t the end of the unit.
- Ensure that ever t answer all the ques

Sugges e ques o ask students:

- Ask students to explain the term Product quality.



Skill India
कौशल भारत - कुशल भारत



सत्यमेव जयते
GOVERNMENT OF INDIA
MINISTRY OF SKILL DEVELOPMENT
& ENTREPRENEURSHIP



N · S · D · C
National
Skill Development
Corporation

Transforming the skill landscape



4. Maintain Work Area, Tools and Machines

Unit 4.1 - Maintain Work Area, Tools and Machines

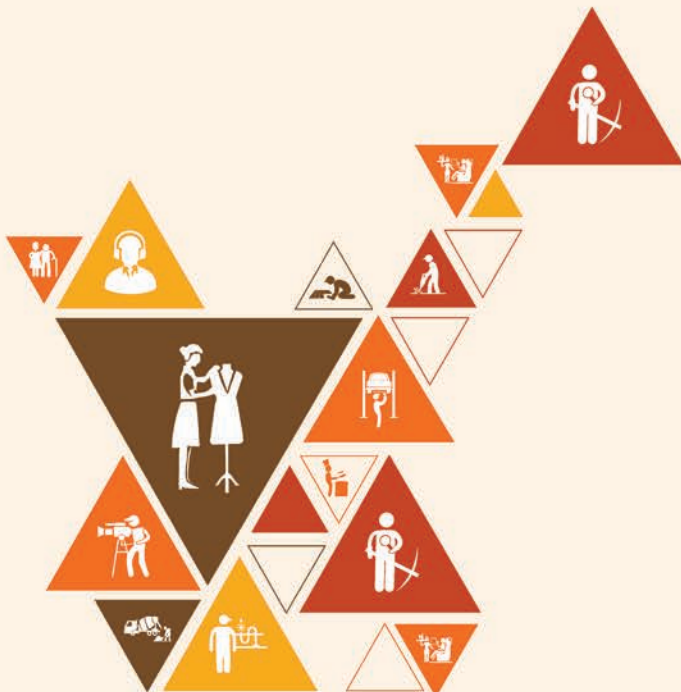

AMH/N0102

UNIT: 4.1 Maintain Work Area, Tools and Machines



At the end of this unit, the students should be able to:

1. Practice safety and maintain machines properly.
2. Carry out basic maintenance of machine.
3. Maintain tools and equipments and handle them safely.
4. Use materials to minimize waste.
5. Carryout running maintenance within agreed schedules.
6. Carry out maintenance and/or cleaning within one's responsibility.
7. Work in a comfort correct posture.
8. Use cleaning equipment and methods appropriate for the work to be carried out.
9. Dispose of waste safely in the designated loca
10. Store cleaning equipment safely after use.
11. Carryout cleaning according to schedules and limits of responsibility.

Resources to be Used

- Available objects such as black or white Board, chalk pieces or white board marker pens, duster
- PC with LCD Projector or Flip Chart
- Copies of handouts, Participants Handbook

Do

- Greet and welcome students to the next session of the program.
- Before start they have any doubts pertaining to the previous unit.
- Capture their responses on board and share them wherever necessary.
- Tell them that they will learn about Finishing Department Work

Say

- Machines are essential to modern production. However, along with increased productivity, they have brought hazards into the workplace. Proper control of machine hazards has traditionally been seen as costly and a constraint on productivity. In general, the garment manufacturing industry is considered to be less dangerous than other industrial sectors and, therefore, safety policy is a low priority in many enterprises. For example, it has been observed that some workers remove guards protecting belts from sewing machines and manually operated with naked hands.

Do

- Teach the students about the techniques of maintaining machines.
- Make them learn how to clean the Bobbin area.
- Explain the steps of cleaning the feed dog assembly.
- Explain the steps of lubricating the machine and also make them understand the importance of the machine guards.
- The basic steps of maintaining the machine should be thoroughly demonstrated to them.
- Lastly, it is extremely essential to make them understand the safety hazards that are common towards using and handling the machine.

Demonstrate

4.1.2.2 Cleaning the Bobbin Area

- **Step 1:** Turn off the sewing machine.
- **Step 2:** Remove the bobbin cover and the bobbin.
- **Step 3:** Using a small lint brush (many machines come with one), carefully remove any lint from the bobbin area. Be especially sure to remove any lint from crevices and tight places, since compacted lint can actually stop the machine from running.
- **Step 4:** Using the lint brush or canned air, remove the lint from the area around the needle, the presser foot and the thread guides.
- **Step 5:** Remove any lint from the inside of the doors and lids of the sewing machine.
- **Step 6:** Replace the bobbin and the bobbin cover.
- **Step 7:** Plug the sewing machine back in and turn it on.

Note: Make sure to check that after cleaning all the machine parts are properly placed and tightened. It should be safe for using it the next time.

4.1.2.3 Cleaning the Tension Assembly

- **Step 1:** Clean your machine **often**. Each **step** is precise and even a bit of lint collected on the tension assembly can cause problems. Make it a habit to clean your sewing machine **after** any large project.
- **Step 2:** Raise the pressure foot to release the tension on the disks. Gently run the folded edge of a clean piece of lint free cloth through the tension disks. Compressed air will also dislodge any bits of thread or lint.
- **Step 3:** Remove all lint along the thread guides using a small brush or clean cloth.
- **Step 4:** Check the bobbin area of the machine. The bobbin controls the lower tension and can be a source of built up lint. Depending on the type of machine you have, the bobbin consists of the bobbin, case and on some models a removable hook race. Remove these according to your **instructions** manual and clean with a cloth or small brush.
- **Step 5:** Do a **final** check to make sure the tension is correct and that the bobbin assembly is in place properly before you begin your next project.

4.1.2.4 Cleaning the Feed Dog Assembly

- **Step 1:** Unplug the machine and examine the feed dogs. The newer machines have metal feed dogs, but older models may have **plastic** ones need replacing. Examine the feed dogs and check for damage.
- **Step 2:** Remove the throat plate, which is the covering over the feed dogs, and clean it with a **lint free** cloth. Use a small **brush** to clean the feed dogs. Make sure to remove all lint and thread from the grooves of the teeth. Some machines have an adjustment that lowers the feed dogs for **topstitching** sewing procedures. They should be in the **lower** or **higher** viewing during the cleaning process.
- **Step 3:** Clean the area around the feed dogs with a **brush**. Compressed air is a good choice to use in the **tight** areas.
- **Step 4:** Wipe down all areas with a clean, lint free cloth before replacing the throat plate.
- **Step 5:** Prepare to clean the feed dogs and all other areas that lint may accumulate on, **after** every project. Your sewing machine will last longer and need fewer repairs if kept clean and lint free.

4.1.3 Steps in Lubricating Machine

- **Step 1:** Purchase a high-quality brand of sewing machine oil from a sewing store or other specialty retailer. Higher quality generally comes with a higher price tag, but the price of good sewing machine oil is favorable to the costs involved with repairing or replacing an **entire** sewing machine.
- **Step 2:** Unplug your sewing machine. Make sure its power switch is set to **off**. Because you will be dealing with **oil** it is important to make absolutely certain any power supply is disconnected.
- **Step 3:** Drop a single drip of sewing machine oil onto the mechanism that drives the sewing needle. If you purchased quality sewing machine oil, more than one drop will generally not be necessary.
- **Step 4:** Repeat Step 3, applying a single drop of oil to every part of your sewing machine that moves. Consult your sewing machine owner's manual if you need **instructions** on how to access any moving parts that may be contained beneath the casing of the machine.

- **Step 5:** Allow the oil to absorb by leaving your sewing machine stand for a few minutes. Most experts suggest that 15 to 30 minutes is a good window of time to let your machine stand while the sewing machine oil works its magic.
- **Step 6:** Plug your sewing machine back in. When you have safely done so, turn the power switch to 'on.'
- **Step 7:** Feed some scrap fabric through the sewing machine, running its moving parts at a slow but constant rate. This will allow the oil to spread evenly throughout the parts that require lubrication to maintain optimal performance.

Elaborate

Machine Guard

There are inherent safety guards given in the sewing machine which are important to use and it is also essential to check that the correct safety guard is in place as per the requirement. Below are given the machine guards of a sewing machine.

- Finger guard
- Eye guard
- Belt guard
- Motor pulley guard

Troubleshoot Common Machine

In several cases machine issues are due to the employee not having received correct training in basic machine maintenance. This causes issues that need to be corrected by a professional mechanic/technician. All garment workers are vulnerable from such issues to varying degrees. Some common causes are:

- Incorrect needles
- Incorrect machine settings or the fabric
- Inexperienced workers
- Inexperienced mechanics/technicians
- Fatigue

On-the-job training sessions could also be organized for beginners as part of their training period. Enlist the assistance of senior operators with teaching skills. Group work will provide good support for these training sessions. Sessions ought to embrace acquiring the essential sewing skills and troubleshooting issues.

Carry out Basic Maintenance of Machine

It is important to carry out basic maintenance of own machine and surroundings. While operating a sewing machine we can keep a check of these two maintenances by keeping an eye on the needle point i.e.

- Must check the needle point and stitch quality while working. Be alert and look for any kind of oil leakage. If oil is found, replace (or inform) immediately. For hazard free environment always keep the hook area clean and

- **R** **tenance:** This covers sub kinds of maintenance i.e.
 - » Daily maintenance of the machinery
 - » Weekly maintenance
 - » Monthly maintenance



In the industry visit:

- Make the students show you about the maintenance techniques.
- Ask them to clean and dispose wastes
- Ask them to demonstrate them the store cleaning equipments.

Notes for Facilitator



- Summarize the main points.
- ts if they have any doubts.
- Encourage them to ask ques
- Answer their queries sa factorily.
- T ts to complete the ques t the end of the unit.
- Ensure that ever t answer all the ques

(Suggest e Note)As per students give pr al ques our choice to understand the student's outcome.

Key Learning Outcomes

At the end of this module, you will be able to:

1. Comply with health and safety related instructions and procedures available to the workplace.
2. Use and maintain personal protective equipment as per protocol.
3. Maintain a healthy lifestyle and guard against dependency on intoxicants.
4. Follow environment management system related procedures.
5. Identify and correct unsafe conditions and equipment.
6. Report any serious hazards that can not be rectified.
7. Store materials and equipment in line with manufacturer's and organization requirements.
8. Safely handle and move waste and debris.
9. Minimize health and safety risks to self and others due to occupational hazards.
10. Report hazards from supervisors or other authorized personnel in case of perceived risks.
11. Monitor the workplace and work processes for potential hazards and threats.
12. Carryout periodic walk-through to keep work area free from hazards and obstructions.
13. Report hazards and potential hazards/threats to supervisors or other authorized personnel.
14. Participate in mock drills/ evacuation procedures organized at the workplace.
15. Undertake emergency response training, if asked to do so.
16. Take necessary safety measures.
17. Follow organization procedures.

Do 

- Greet and welcome participants to the next session of the program.
- Before starting, ask participants if they have any doubts pertaining to the previous unit.
- Capture their responses on board and share them wherever necessary.
- Tell them that they will learn about Finishing Department Workplaces.

Say 

Tell participants about:

- The good effects of cost-effective workplace design.
- The requirements of light and air in the workplace.
- The accidents that might take place in the process.
- The safety hazards and the safety measures.
- Understanding the safety signals and symbols.

Do 

- Introduce the students to the health hazards that they might face in this employment over the long run.
- Explain the potential health hazards that apparel workers might face.
- Tell them about the environmental standards that should be taken care of by them.
- Make them understand the value of daylight and indoor air quality health aspects.
- Explain the importance of ergonomics in the workplace.
- Explain the importance of proper sanitation and hygiene.

Elaborate 

Ergonomically-designed workplaces ensure that an employee who is tall is given a comfortably enough space in or near his/her workspace so that the work is not hindered. Similarly, an employee who is shorter is able to reach all of his or her tools and products without undue discomfort and safe assortment. Workers are usually compelled to work in the conditions of the job or workstation that previously was designed with no dynamism or change when they are hired. This leads the workforce to work in awkward postures and long hours, all of which may result in work-related injuries/disorders.

Injuries and illnesses among textile workers

- 81% complained CTDs to the wrist.
- 70% of Tailor complains of back pain.
- 49% of worker suffering from neck pains.
- 35% report observe lower back pain.
- 25% have suffered a compensable increasing trauma disorder
- 14% reported CTDs to the elbow.
- 5% reported CTDs to the shoulder.
- Absenteeism increases as working conditions worsens.
- High employee turnover is associated with detrimental working conditions
- Embroidery tasks are associated with pain in the shoulders, wrists, and hands.
- Ironing by hand is associated with elbow pain.
- Tasks in frames like of work, are associated with CTDs of the hands and wrists.

Some fundamental ergonomic principles that should be followed in our workplaces are:

- **Proper tools:** Tools should be appropriate for the tasks being performed. Your tools should allow you to keep your hands and wrists straight – the way they would be in if they were hanging relaxed at your side. The workers should bend the tool – not the wrist.

The tool should fit comfortably into your hand. If the grip size is too large or too small, it will be uncomfortable and will increase the risk of injury. Tools should not have sharp edges, create contact stresses in your hand, or vibrate.

- **Keep repetition to a minimum:** Workstation or tasks can often be redesigned to reduce the number of repetition that must be performed. Using a power-driven screwdriver or tools with a ratchet device can reduce the number of twists with the arm. For prevention of ergonomic injuries, workers should be encouraged to change work and take frequent but short breaks. Workstation should have enough space for the given tasks and provide proper seating. Manufacturing tools and machinery should incorporate ergonomic design principles and should not require an excessive amount of force to operate. Some tasks can be automated or redesigned to eliminate repetitive movements and musculoskeletal injuries.
- **Avoid awkward postures:** Your job should not require you to work with your hands above shoulder height on a regular basis. Arms should be kept low and close to your body. Bending and twisting of your wrists, back and neck should also be avoided.
- **Use safe procedures:** Avoid heavy objects that are too heavy. Use more than one person or a mechanical device to reduce the load. Your workstation should not require you to lift objects above your head or twist your back while lifting. Keep the load close to your body and ensure that you have a good grip. Heavy and frequently used objects should be stored between knee and shoulder height – not on the ground or above your head.
- **Get proper rest:** The workers need to rest their body and mind in order to prevent injuries. Give your muscles a rest during your coffee breaks, lunches and weekends by doing something different from what you do in your job.

For example, if you stand all day, while performing your job you should sit down to rest your legs and feet during your breaks. If you sit down, when working you should stand up and walk around during your breaks to give your back a rest and to increase circulation in your legs. By doing this the musculoskeletal injuries can

be prevented.

- **Other things to consider:** Chemicals also have a part in garment manufacturing. Dyes, enzymes, solvents and other chemicals are used to create different fabric and provide durability to the product. Proper ventilation and personal protective equipment are important for protection of workers engaged in chemical processing. Similarly, for workers who handle the hazardous material and may be exposed to excess chemicals, ventilation, protective equipment should be used.

Good Lighting or Quality Products

Good lighting does not mean more light bulbs and more use of electricity. Natural lighting is usually a better option than the bulbs. But if there is a problem in arranging for a natural lighting through windows and ventilators, it is important that the bulbs and other elements of artificial lights should be well-maintained. A good lighting arrangement is directly proportional to an efficient workforce.

You will learn from this topic how to attain better lighting without increasing the electricity bill; you may even pay less and your business, as well as the workers, will definitely benefit from these improvements.

First of all one has to identify if at all you need to work upon the existing brightness level in the work place. Lighting requirements are reliant on three main features:

- The nature of the task
- The sharpness of the worker's eyesight
- The environment of the working area

Natural light is the best and the cheapest source of illumination. One had to gauge the surface area of the work area and measure the windows and skylights. Ideally the open space that includes the windows, ventilators and door should be one-third of the total area of work.

Risks and an Incident

Your responsibility requires you to be aware of potential hazards and correct reporting processes. If you face a potential hazardous situation, e.g.: a client expressing violent behavior, it is important that you report it immediately to management in appropriate forms as legally required of you.

If they are injured at work they must:

- Report the injury to management as soon as possible, and certainly within 24 hours.
- Seek proper treatment for their injury.

Sanitary Facilities

There are several reasons why the provision of washing facilities is important:

- Dirt and grime can be ingested and cause sickness or disease; they are, in any case, unpleasant and unhygienic.
- Washing is required for basic hygiene after using the toilet.
- Washing is a necessity when women have their monthly periods.

Ready for Emergencies

Misfortunes can happen even if proper defensive measures are installed. So, always be prepared for emergencies and have readiness for disaster management, like cuts and bruises, eye injuries, burns, poisoning and electric shocks. Every enterprise should maintain a well-stocked first-aid box and assign at least one person from every department to handle emergencies. First-aid boxes should be clearly marked and situated in a place, so that they are easily accessible.

readily reachable in an emergency. They should not be more than 100 metres away from any place on the work site. Ideally, such kits should be near a wash-basin and in good light. Their supplies need to be regularly checked and replenished. The contents of a first-aid box are often regulated by law, with variations according to the size and the likely industrial hazards of the enterprise. A typical basic kit may include the following items in a dustproof and waterproof box:

- Sterile bandages, pressure bandages, dressings (gauze pads) and slings. These should be individually wrapped and placed in a dustproof box or bag. A range of different sizes should be available at all times to treat small cuts and burns.
- Cotton wool for cleaning wounds
- Scissors, tweezers (for splinters) and safety pins
- An eye bath and eye wash
- Ready-to-use antiseptic cream
- Simple over-the-counter medicines such as aspirin and antacid
- A booklet or leaflet on first-aid treatment

Safety Signs at Workplace

Safety Signs: Signs providing information or instructions about safety or health at work by means of a signboard, a colour, an illuminated sign or acoustic or verbal communication.

Signboard: A sign which provides information or instructions by a combination of shape, colour and a symbol or pictogram which is rendered visible by light of a certain intensity. In practice, many signboards may be accompanied by supplementary text, eg 'Fire exit', alongside the symbol of a moving person. Signboards can be of the following four types:

1. Prohibition sign
2. Warning sign
3. Mandatory sign
4. Emergency escape, Fire and First-aid signs



In the industry visit, make sure that the students:

- Use and maintain personal protective equipment as per protocol.
- Maintain a healthy lifestyle and guard against dependency on intoxicants.
- Follow environment management system related procedures. » Identify and correct (if possible) in machinery and equipment.
- Store materials and equipment in line with manufacturer's and organizational requirements.
- Minimize health and safety risks to self and others due to o
- Monitor the workplace and work processes for potential hazards and threats.
- Carryout periodic walk-through to keep work area free from hazards and obstructions.
- Report hazards and potential hazards/threats to supervisors or other authorized personnel.
- Participate in mock drills/ evacuation procedures organized at the workplace.
- Undertake emergency response training, if asked to do so.
- Take necessary precautions.

Notes for Facilitator



- Summarize the main points.
- Clarify doubts if they have any doubts.
- Encourage them to ask questions.
- Answer their queries satisfactorily.
- Try to complete the questions at the end of the unit.
- Ensure that everyone answers all the questions.

Suggested questions to ask students:

- Ask students to list some fundamental ergonomic principles that should be followed in SMO's workplace.
- Ask students to explain Safety signs of workplace.



Skill India
कौशल भारत - कुशल भारत



सत्यमेव जयते
GOVERNMENT OF INDIA
MINISTRY OF SKILL DEVELOPMENT
& ENTREPRENEURSHIP



N · S · D · C
National
Skill Development
Corporation

Transforming the skill landscape



6. Comply with Industry, Regulatory and Organiza Requirements

Unit 6.1 - Comply with Industry, Regulatory and Organiza

requirements

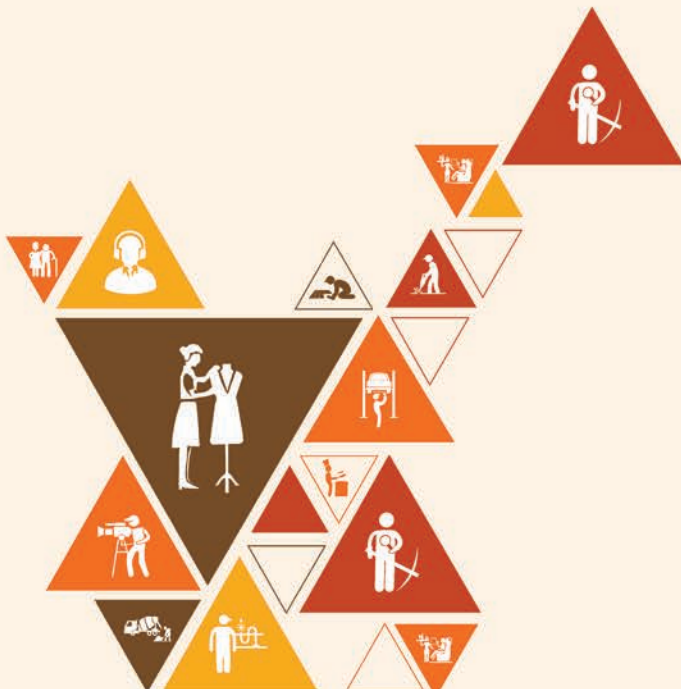

AMH/N0104

Key Learning Outcomes

At the end of this module, you will be able to:

1. Carry out work in accordance with legislative and regulatory organizational guidelines and procedures.
2. Seek and obtain assistance on policies and procedures, from your supervisor or other authorized personnel.
3. Apply and follow these policies and procedures within your work practice.
4. Provide support to your supervisor and team members in enforcing these considerations.
5. Identify and report any possible deviations to these requirements.

UNIT: 6.1: Comply with Industry, Regulatory and Organizational Requirements

es

At the end of this unit, the students should be able to:

1. Carryout work in accordance with legisla and regula organiza guidelines and procedures.
2. Seek and obtain a on policies and procedures, from your supervisor or other authorized personnel.
3. Apply and follow these policies and procedures within your work pr
4. Provide support to your supervisor and team members in enforcing these considera
5. Iden y and report any possible devia o these requirements.

Resources to be Used

- Available objects such as black or white Board, chalk pieces or white board marker pens, duster
- PC with LCD Projector or Flip Chart
- Copies of handouts, P ts Handbook

Do

- Greet and welc ts to the next session of the program.
- Before st y have any doubts pertaining to the previous unit.
- Capture their responses on board and share them wherever necessary.
- Tell them that they will learn about Finishing Department W w

Say

- The clear and crisp de ompliance.
- ance of compliance in Indian Garment Industry.
- Enlighten them about the core labor standards of India.

- Explain the role played by AEPC in the Garment Industry in India.
- Talk about the social responsibility towards this end.
- Explain the importance of ethics.
- State the labour laws and tell them about their rights, compensa
- Health and safety compliance should be explained.
- State the codes of pr e needed to be noted.

Elaborate

De or Your Organiza

According to *Merriam Webster* y de ompliance is as follows:

1. The act or process of complying to a desire, demand, proposal, or regimen, or to coercion.
2. Conf equirements.
3. o yield to others.
4. The ability of an object to yield elas ally when a force is applied.

Supervisory compliance for industries, world- wide falls under the second de There are many managers, general councils, and policy s that would consent in agreement at any of the other de as well. Let's discuss, what is compliance? Whether an organiza is confron an external regulatory compliance from a government agency, or seeks to comply with its own organiza mandates, policies or procedures, compliance in actuality means conforming to requirements and a proof that your organiza has done so. This is usually a ined by the scheming and development of managerial policies that will map out the projected code of conduct.

ance of Compliance in Indian Garment Industry

Compliance is the standard for the product which ensures that it is aligned to its industry's qualita e demands. This also includes audits and which are crucial to a proper and formal work environment. Compliance and its demand is rapidly growing in today's industrial scene since globaliza of manufacturing standards has also created a demand for ethically created products. This standard of compliance is crucial because of the increase in export of garments from India.

Social Compliance: The treatment of the employees by its business cons es social compliance. This also includes their environment and their personal per e on social responsibility as an employee. The treatment of employees regarding wages, work c and working hours. A compliance audit is necessary in order to determine if the company meets standard environmental laws.

Compliance Audit: Process Safety Management, Risk Management Programs, and Process Security Management are all organized and provided by audits and assessments. Compliance and its v a is carried out with audits that focus on these policies and procedures. The design and implementa of these audits ensures this compliance. , all sorts of de can be addressed and solved through corr e

In India, compliance audit consists of a thorough examina of orders, regula rules and dir for dealing with prudence, legality, transparency and adequacy. It is the job of auditors to collect informa by

reviewing documents, visually observing the site and staff interviews. This data is cross checked with applicable regulations and permits to ensure how well the operation is when sieved through applicable and required legislation.

There are three main phases of compliance audit in India:

1. **Pre-audit:** It includes planning and organising the audit; establishing the audit objectives, scope and extent; and reviewing the design of the program before commencement.
2. **On-site audit:** It includes conducting personnel interviews, reviewing records, and making observations to assess program implementation.
3. **Post-audit:** It includes brief communication and reporting.

Core Labour Standards

- Removal of Discrimination in Employment and Occupation
- Freedom of Association
- Right to Collective Bargaining
- Elimination of Forms of Forced or Compulsory Labour
- Equal Remuneration

Apparel industry players would ensure that labour contractors don't involve forced labour or child labour and get the supply chain of the suppliers audited. Apparel Export Promotion Council (AEPC), a top organization of Indian apparel exporters, has envisioned a garment factory compliance program 'Disha' -Driving Industry towards Sustainable Human Capital Advancement. The prime objective of this body is to make India a global benchmark for social compliance in apparel industry. This Common Compliance Code design will prepare the Indian apparel industry on a mutual platform towards a more social and ecologically compliant industrial atmosphere.

AEPC-Disha

Apparel Export Promotion Council (AEPC), the peak body of Indian apparel exporters, has launched an agenda, named it "DISHA" (Driving Industry towards Sustainable Human Capital Advancement) with a primary objective to aid garment exporters comply with global standards referring to child labour.

This program is directed to encourage members to follow better social practices. These practices will give them a competitive edge in the global market. That market, where industrial compliance code is progressively becoming an important factor in buying decision.

Responsible Factory

DISHA member factory is dedicated to subscribe to the DISHA common code of conduct (CCC) Principle on child labour and takes the responsibility to:

- Comprehend and classify applicable laws and acts.
- Understand general industry practices.
- Establish management systems for nourishment and development.

Disha-CCC for child labour

The CCC- Common Code Of Conduct is based on various central and state laws. Some of the laws that regulate the employment of children and young persons are as follows:

- No child who has not completed fourteenth year of age shall be required or allowed to work in any occupation in the factory.

- Persons who have completed fourteenth, but not eighteenth, year of age are not employed in hazardous or dangerous opera
- No female young person shall be required or allowed to work in any factory except between 8.00 A.M. and 7.00 P.M.
- Young people are required to work only after obtaining a certificate of fitness from a government medical officer not below the rank of an Assistant Surgeon. The fee for obtaining this certificate would be borne by the factory.

AEPC's assistance to garment exporters

AEPC brings about invaluable backing to Indian garment exporters and also the international buyers who select India as their favoured trading terminus for garments. The body today has grown-up to become the most powerful connotation for promotion and facilitation of garment exports. With an emphasis on structuring a strong ground for Indian exporters, AEPC is devoted to provide various podiums which would help in increasing garment exports.

e

AEPC in its unceasing efforts to make India a preferred sourcing end point plans to undertake a series of projects to reinforce the compliance code volume in the Indian export garment industry. The project DISHA has been originated with the aim to merge the Indian apparel manufacturers for mutual cooperation, global connectivity and resource optimization. It also focuses to create and adopt management systems to address human and ecological encounters.

Purpose of Disha programme

- To increase mindfulness among apparel companies on social and environmental standards based on applicable Indian laws.
- To progress efficiency of apparel manufacturer.
- To promote a management system oriented thinking and approach for engaging with social and environmental issues.
- To promote a progression-based award system that supports quantification of progress towards adoption and upkeep of yards.

Main components of Disha

Ecological, societal and security linked compliance issues are increasing importance in fabrics and apparel sector. The competitiveness in the sector moves to new embryonic markets. Improved social sustainability of the industry and creation of an atmosphere for improved compliance principles can give India the mandatory edge over its competitors in the global market. Some of the major mechanisms of the program Disha are:

- **Common Code of Conduct (CCC):** Common Code of Conduct (CCC): AEPC-Disha's common code of conduct is intended to lead the Indian apparel manufacturers on legal, social and environmental issues. The program creates the values for business responsibility, based on applicable Indian laws and International Labour Organisation (ILO) standards approved by the Government of India.
- **Factory Capacity Building & Training:** The common code of conduct includes orientation for the owners of apparel factories and capacity building for factory-nominated personnel on Disha-CCC and towards applying the management systems for Disha-CCC.
- **Baseline & Impact Assessment:** Before the commencement of the program, a factory shall undergo a pre-interference baseline evaluation for gap analysis against the Disha-Common Code of Conduct (CCC) ideologies and benchmarks. Post-intervention assessments on operational and management systems in the factory shall be undertaken.

Indian Garment Industry and Social Responsibility

The apparel industry of India, is one of the biggest segments among the various industries exist. It is also one of the oldest and an eminent industry in terms of output, investment and employment. A sector which has a global market share and has earned reputation for its permanence, worth and growth. The industry is growing at a fast pace with change in customer taste and inclination. There are numerous factors causing a change in customer preferences. Few of them are here:

- Rise in disposable incomes
- Increasing demand for branded apparels and fashion accessories
- Convenience of shopping at departmental stores and shopping malls
- Boom in the retail industry
- Government policy focused on fast-track growth

Internal Standards

The Indian apparel industry had established itself substantially not just in the domestic but global market too. The improved density from internal apparel buyers to comply with labour principles and rights in Indian garment factories has resulted into a vast number of labels and code of conduct.

Why Code of Ethics is Required

The code of ethics is concerned with the quality of the products and services from the workplace along with the working environment that should meet the provisions of audits and assessments. If followed sincerely, these ethics will result into:

- Cumulative accountability in terms of social compliance.
- Growing competitiveness of small scale industrialists.
- Dropping burden on manufacturers.

Some of the compliance codes in Indian garment industry are listed below.

Working Hour & Wage Rate Compliance

- Garment workshops should ensure a condition that employees should get minimum wages as per the domestic law and according to their working hours spent by them in the industry.
- Employer should confer an equal wages to both men and women employees who are performing the same work or work of a similar nature.
- Workforce employed for more than nine hours on any day or for more than 48 hours in any week, shall be paid overtime wages at premium legal rates for such overtime work.
- Every employee must be entitled to one holiday in a week.
- Whenever a worker is required to work on a weekly holiday, he is to be allowed a compensatory holiday for each holiday so lost.

Need for Compliance Codes

There is prominent impact of social compliance on company's economic outcomes. Companies should adopt compliance code to protect their goodwill and brand name in the market. The Indian apparel industry needs to be hard on compliance rather than opposing with other developing countries manufacturing low-cost garments.

Compliance Code Guidelines

Apparel factories ought to contemplate the below mentioned guidelines when complying with safety and health compliance code standards:

- Trades should comply with international standard code, such as ISO or countries standard code to become competitive in international markets.
- It is necessary for workers involved in loading and unloading operations.
- Young adults (between 15 to 18 years) are not allowed to work on any dangerous machine without proper training and supervision.
- Ear plugs or muffs should be given in places with excessive sound such as generator rooms and embroidery rooms.
- Factories should have effective exit routes for emergency usage in case of fire.
- Eye-wear and face shields should be a must, providing in areas with danger of flying objects, sparks, glare, hazardous liquids and excessive dust.

Role of Apparel Export Promotion Council

In India, the Apparel Export Promotion Council (AEPC) is constituted to legal compliance and ethical business practices and encourages members/exporters to comply with all applicable laws and regulations of the country to meet international compliance standards.

Further, the council has designed a garment factory compliance program 'Disha' (Driving Industry towards Sustainable Human Capital Advancement) that aims to spread awareness regarding the importance of compliance among garment exporters.

Compliance Code Guidelines for Indian Garment Industry

The Indian apparel industry supports considerably to India's export earnings. India has industrialised as a major manufacturing hub for various buyers. The USA and the EU endure to be the most dominating markets for Indian apparel industry, bookkeeping for about two-third of India's textile exports. These countries have been demanding upon compliance to certain social, environmental and safety standards and norms by the manufacturing units involved in export business. Corporate codes of conduct that discourses labour standards vary from corporate to corporate and local to local. Some of the common Indian Garment industry compliance code guidelines are:

- Exporters must not be intricate in unfair labour practices but limited to interferences in matters regarding freedom of association.
- Exporters shall recompense workforce for all hours operated. Workers on a piece rate payment scheme or any other incentive scheme should be paid according to that.
- Exporters shall not illogically restrain the liberty of movement of workers, including movement in canteen during breaks, using toilets, accessing water, or to access necessary medical assistance as a means to maintain work discipline.
- Exporters are about to offer workers with paid annual leaves as required under local laws, guidelines and processes. Exporters shall not impose any undue limitations on workers' use of annual leave or taking any type of sick or maternity leave.
- There shall be no alteration in workers remuneration for work of equal value on the basis of gender, race, religion, age, nationality, sexual orientation, marital status, physical disability or ethnic origin.
- Exporters shall not threaten female workers with termination or any other employment conclusion that adversely affects their service status in order to avert them from getting pregnant.

- Exporters shall ensure that proper ventilation systems are installed within their premises to prevent airborne exposures which may affect the health of workers.
- Members shall not commit any form of physical or mental, sexual violence, threats, harassment, or abuse against workers seeking to form organisations or unions or go on strikes.
- Workers shall be entitled to at least 24 successive hours of rest in every seven-day period. If workers must work on a rest day, another successive 24 hours rest day must be provided.
- Exporters shall pay workers at least the legal minimum wage or the usual industry wage, the one that is higher. This indeed is the most essential code of compliance for Indian Industry.
- Garment exporters must ensure that the minimum age requirement to unsafe employment shall not be less than 14 years. This is the most important concern in the country. Each worker has the right to enter into and to terminate their employment freely. Indian apparel makers need to follow all the compliance rules to comply with global standards. When companies adopt industry compliance codes to project a better image and protect their goodwill in the market. The Indian garment industry needs to be strong on compliance instead of competing with other developing countries manufacturing inexpensive garments.

Indian apparel makers need to follow all the compliance rules to comply with global standards. When companies adopt industry compliance codes to project a better image and protect their goodwill in the market. The Indian garment industry needs to be strong on compliance instead of competing with other developing countries manufacturing inexpensive garments.

Code of Conduct for Garment Exporters

- Garment exporters must safeguard that the minimum limit of the age requirement to non-hazardous employment should not be less than 14 years. Moreover, all young workers (between 14 to 18 years) must be sheltered from doing any work that is likely to be dangerous or that may be injurious to their health and physical, mental, social, or moral development. Exporters must detect all legal violations for work being performed by lawful young workers.
- Further, the apprentice or vocational students shall not be under the legal age for working (as provided under the applicable laws). They cannot be used on regular production lines as long as they are apprentices and unless their pay and other benefits are at par with the regular workforce.
- A proper process is followed for verifying the age of the workers. The minimum documents required to be maintained shall include- proof of age certificates by registered/licensed dentists, birth certificate, school leaving certificate, national identity like passport, driving license, voter card etc. or any other document required under the applicable laws.

Notes for Facilitator



- Summarize the main points.
- Encourage students if they have any doubts.
- Encourage them to ask questions.
- Answer their queries satisfactorily.
- Try to complete the questions by the end of the unit.
- Ensure that every student answers all the questions.

Suggested questions to ask students:

- Ask students to evaluate the importance of Compliance in Indian Garment Industry.
- Ask students to discuss the role of Industry & Social responsibility.



Skill India
कौशल भारत - कुशल भारत



सत्यमेव जयते
GOVERNMENT OF INDIA
MINISTRY OF SKILL DEVELOPMENT
& ENTREPRENEURSHIP



N · S · D · C
National
Skill Development
Corporation

Transforming the skill landscape



7. Professional Skills

Unit 7.1 - Professional Skills

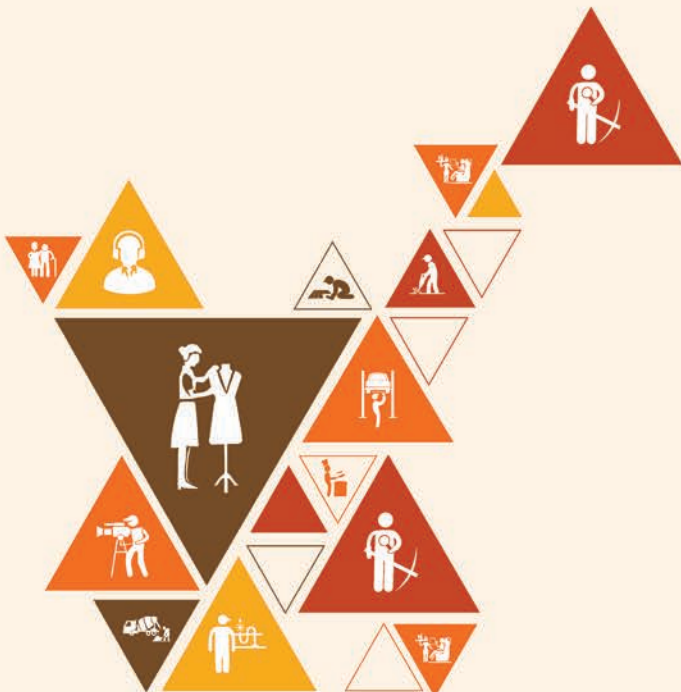

Key Learning Outcomes

At the end of this module, you will be able to:

1. Work effectively within a team.
2. Manage job related stress effectively.
3. Understand the importance of punctuality.
4. Understand the causes of AIDS.
5. Know prevention methods for AIDS.
6. Importance of health and hygiene.
7. Effects of alcohol and tobacco.

UNIT: 7.1 Professional Skills

es

At the end of this unit, the students should be able to:

1. Work effectively within a team.
2. Manage job related stress effectively.
3. Understand the importance of punctuality.
4. Understand the causes of AIDS.
5. Know prevention methods for AIDS.
6. Importance of health and hygiene.
7. Effects of alcohol and tobacco.

Resources to be Used

- Available objects such as black or white Board, chalk pieces or white board marker pens, duster
- PC with LCD Projector or Flip Chart
- Copies of handouts, Participants Handbook

Do

- Greet and welcome participants to the next session of the program.
- Before starting, participants may have any doubts pertaining to the previous unit.
- Capture their responses on board and share them wherever necessary.
- Tell them that they will learn about Finishing Department Work

Say

- Explain the importance of team work taking examples from real life scenarios.
- Enlighten about the roles and responsibilities of working in a team.
- Explain about the stress management techniques.
- Speak about the requisites of punctuality.
- Make them aware of AIDS/HIV.
- Explain the health and hygiene concerns.
- Tell them the negative and harsh impacts of alcohol and tobacco consumption.
- Elaborate on the various elements of team work like collaboration, communication, etc.
- About the possible conflicts and resolving points of views.
- Tell them as to how can they analyse stress.
- Make them understand the ways of prevention.

Notes for Facilitator

- Summarize the main points.
- Encourage them to ask questions if they have any doubts.
- Encourage them to ask questions.
- Answer their queries satisfactorily.
- Try to complete the questions at the end of the unit.
- Ensure that everyone gets to answer all the questions.

Suggest questions to ask students:

- Ask students to explain stress management techniques.
- Ask students to explain the importance of team work.



Skill India
कौशल भारत - कुशल भारत



सत्यमेव जयते
GOVERNMENT OF INDIA
MINISTRY OF SKILL DEVELOPMENT
& ENTREPRENEURSHIP



N · S · D · C
National
Skill Development
Corporation

Transforming the skill landscape



APPAREL MADE-UPS HOME FURNISHING
SECTOR SKILL COUNCIL

8. IT Skills

Unit 8.1 - Introduction to Computer

Unit 8.2 - Basic Computer Knowledge

Unit 8.3 - Components of Computer

Unit 8.4 - Concept of Operating System

Unit 8.5 - MS Word

Unit 8.6 - MS PowerPoint

Unit 8.7 - MS Excel

Unit 8.8 - Internet Concepts

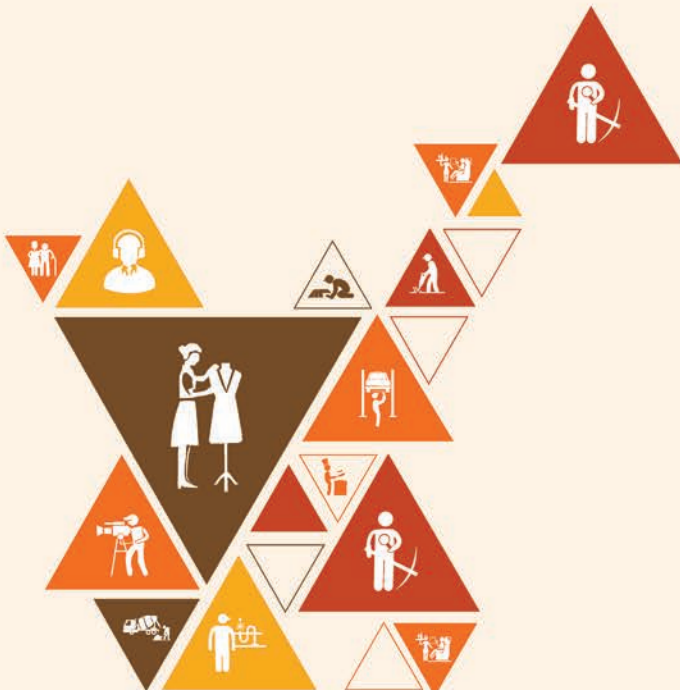

Key Learning Outcomes

At the end of this module, you will be able to:

1. Understand computers
2. Understand and use basic uses of a computer
3. Identify a computer motherboard
4. Understand computer operation system
5. Use and understand Microsoft Word, Excel and Powerpoint
6. Familiarise with Internet and use e-mails

Unit 8.1: Introduction to Computer

Objectives

At the end of the unit, students will be able to:

1. Know what a computer is.
2. Recognise its various parts.
3. Understand the advantages of computer.

Resources to be Used

- Projector Manual
- Computer Lab

Do

- Greet and welcome students to the next session of the program.
- Before starting, students may have any doubts pertaining to the previous unit.
- Acknowledge their responses and clear their doubts if any.
- Tell them they will learn about introduction to computer in this unit.

Say

- Tell students about the computer. Computer plays a very important role in our personal and professional lives. It has become an integral part of our lives.
- Tell them about important characteristics of a computer.

Notes for Facilitator

- Summarise the main points of the unit.
- Encourage students if they have any doubts. Encourage them to ask questions.
- Answer their queries satisfactorily.
- Ask them to answer the questions at the end of unit giving reference to the manual.
- Ensure that every student answers all questions.



- Tutors to demonstrate the parts of computer.
- Give them 15 minutes to prepare.
- Tutor will be given 10 minute to demonstrate the same.
- Once presentations are complete appreciate the efforts made by the group and summarise the highlights of .

Skill Pr	Time	Resources
1. Demonstrator	4 Hours	<ul style="list-style-type: none"> • Participant Manual • Computer Lab

Unit 8.2: Basic Computer Knowledge

es 

At the end of the unit, students will be able to:

1. Know what is a computer.
2. Understand the web, e-mail and media.

Resources to be Used

- P t Manual
- Computer Lab

Do 

- Greet and welcome students to the next session of the program.
- Before start, students should have any doubts pertaining to the previous unit.
- Acknowledge their responses and clear their doubts if any.
- Tell them they will learn about basic computer knowledge in this unit.

Say 

- Tell students about the application of the computer in daily life. In the workplace, many people use computers to keep records, analyze data, do research, and manage projects. At home, you can use computers to inform, store pictures and music, track expenses, play games, and communicate with others—and those are just a few of the applications. Tell them about important characteristics and applications of a computer.
- Now explain the concept of web. The World Wide Web is an enormous warehouse of information. The web is the most prevalent part of the Internet, partly because it exhibits most information in a visually pleasing format.
- Tell them about the application part of the web and introduce them with the use of different applications such as email, instant messaging, picture music and movies with them.

Notes for Facilitator

- Summarise the main points of the unit.
- Encourage students if they have any doubts. Encourage them to ask questions.
- Answer their queries satisfactorily.

- Ask them to answer the questions at the end of unit giving them 10 minutes to read the student's manual.
- Ensure that every student answers all questions.

Suggested questions to ask students:

- Ask students to explain the concept of Web.



- Teachers should assign students to prepare an online report using web.
- Tell them they can choose any topic of their interest. Give them one hour to prepare.
- Teachers should allow each student to be given 10 minutes to present their report to the class.
- Once presentations are complete appreciate the efforts made by the group and summarise the highlights of the presentations.

Skill Practice	Time	Resources
1. Prepare Online report	4 Hours	<ul style="list-style-type: none"> • Student Manual • Computer Lab with internet

Unit 8.3: Components of Computer

es

At the end of the unit, students will be able to:

1. Know what is pre housek
2. Know the reasons for doing cleaning
3. Understand the principles of cleaning
4. Clean material, cleaning equipment and its maintenance

Resources to be Used

- P t Manual
- Personal Prot e Equipment (PPE)

Do

- Greet and welc ts to the next session of the program.
- Before st y have any doubts pertaining to the previous unit.
- Acknowledge their responses and clear their doubts if any.
- Tell them they will learn about the components of the computer in this unit.

Say

- T erent parts of the computer.
- erent parts of motherboard in detail.

Notes for Facilitator



- Summarise the main points of the unit.
- Encourage students if they have any doubts. Encourage them to ask questions.
- Answer their queries satisfactorily.
- Ask them to answer the questions at the end of unit giving reference to the student's manual.
- Ensure that every student answers all questions.

Suggested questions to ask students:

- Ask students to list different parts of a computer.



- Tell students to demonstrate the motherboard.
- Tell them they will get 30 minutes to prepare and each student will have to demonstrate for same.
- Once presentations are complete appreciate the efforts made by the group and summarise the highlights of the activity.

Skill Practised	Time	Resources
1. Demonstrating the motherboard	4 Hours	<ul style="list-style-type: none"> • Student Manual • Computer Lab

Unit 8.4: Concept of Operating System

Objectives

At the end of the unit, students will be able to:

1. Understand the concept and good knowledge of operating system.

Resources to be Used

- Print Manual
- Computer System

Do

- Greet and welcome students to the next session of the program.
- Before start, students may have any doubts pertaining to the previous unit.
- Acknowledge their responses and clear their doubts if any.
- Tell them they will learn about operating system in this unit.

Say

- Tell them about windows XP. And explain that Windows XP let you use different types of applications on the operating system.
- Explain different versions of Windows.

Demonstrate

- Explain tools and parts of an operating system.
- Show them all these parts practically on the computer system.
- Then explain add or delete desktop shortcut from the desktop.
- Also explain how to create a new folder.
- Tell students to create a folder on computer.
- Then explain how to work with windows.
- Now demonstrate the keyboard shortcuts and tell them the correct way to use the keyboard.

Elaborate

Motherboard

The motherboard is the main element inside the case. It is a large rectangular board with combined circuitry that connects the several parts of the computer as the CPU, RAM, Disk drives (CD, DVD, Hard disk or any others) as well as any other peripherals linked via the ports or the expansion slots.

The central processing unit (CPU)

The central processing unit (CPU) performs most of the calculations that allow a computer to function and is sometimes referred to as the “brain” of the computer. It is usually cooled by a heat sink and fan.

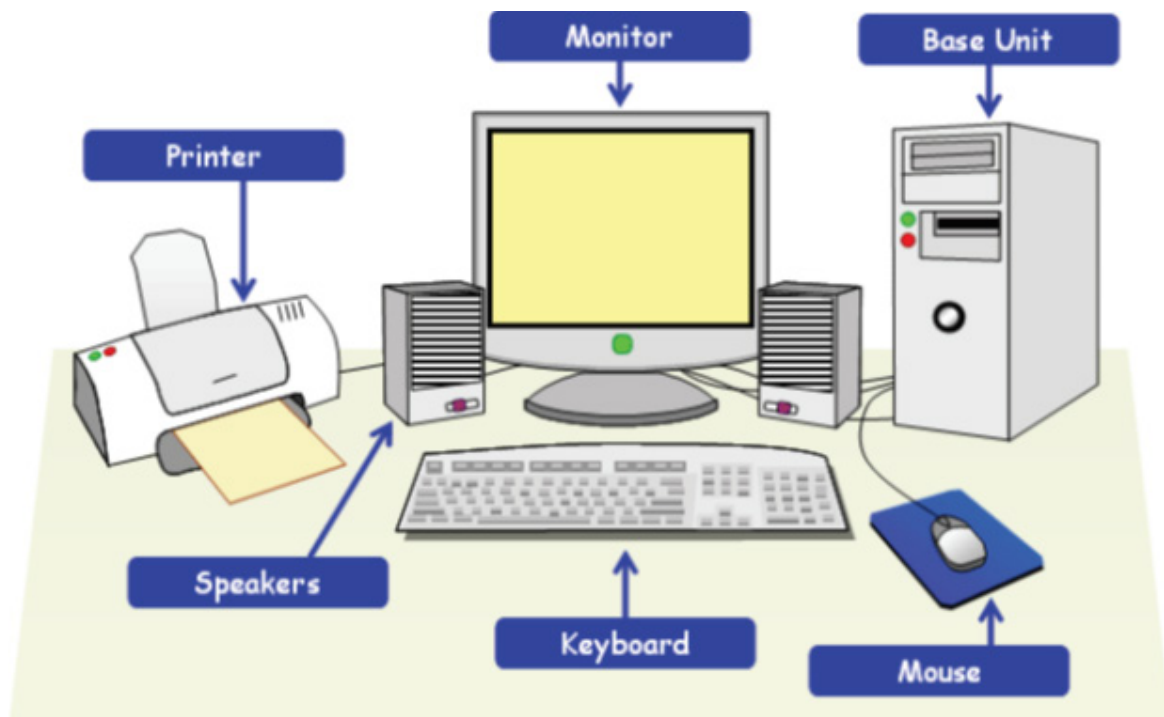

The chip set

The chip set aids communication between the CPU and the other components of the system, including main memory.

RAM (Random Access Memory)

RAM (Random Access Memory) stores all running processes (applications) and the operating system running OS.

The BIOS

The BIOS includes boot firmware and power management. The Basic Input Output System tasks are handled by operating system drivers.

Internal Buses

Internal Buses connect the CPU to various internal components and to expansion cards for graphics and sound.

Notes for Facilitator



- Summarise the main points of the unit.
- Encourage students if they have any doubts. Encourage them to ask questions.
- Answer their queries satisfactorily.
- Ask them to answer the questions at the end of unit giving reference to the manual.
- Ensure that every student answers all questions.

Suggested questions to ask students:

- Ask students to describe the parts of a sewing machine.
- Ask students to explain tools & parts of an Operating System.



- Give one new assignment to each student and tell them they need to type the same.
- Tell them they have to use correct fingers on key board and make sure work is free from errors.
- Give them one hour for typing practice and then discuss the results.
- Finally share the results for correct typing and summarise the highlights.

Skill Practice	Time	Resources
1. Typing Practice	2 Hours	<ul style="list-style-type: none"> • News paper • Computer Systems

Unit 8.5: MS Word

es 

At the end of the unit, students will be able to:

1. Learn the concept and pr -Word.

Resources to be Used

- P t Manual
- Computer System with MS Word

Do 

- Greet and welc ts to the next session of the program.
- Before st y have any doubts pertaining to the previous unit.
- Acknowledge their responses and clear their doubts if any.
- Tell them they will learn about MS Word in this unit.

Say 

- Most people who use a computer daily use word processing skills. word processing skills enable us to prepare text documents like le er erent correspondence.

Demonstrate 

- Tell them to open MS Word in their r e systems.
- Show them how to create a word document in MS wor are.
- Pr ally demonstrate how to perf erent opera ord document as:
 - » Saving a Document
 - » Change Font Type and Size
 - » Create Headers and Footers b exts
 - » Indents and Spacing
 - » Modifying Margins

- » Lists
- » Bulleted and Numbered Lists
- » Formats
- » Spelling and Grammar
- » Word Count
- » Different Elements
- » Header and Table

Notes for Facilitator



- Summarise the main points of the unit.
- Encourage students if they have any doubts. Encourage them to ask questions.
- Answer their queries satisfactorily.
- Ask them to answer the questions at the end of unit giving their own answers.
- Ensure that every student answers all questions.

Suggestion Note: As per student give practical questions their own choice to understand the student's outcome.



- Give one news paper article to each student and tell them they need to type this in MS Word and perform different operations like saving documents, Saving a Document, Change Font Type and Size, Create Headers and Footers by using different styles, Indents and Spacing.
- Tell them they have to use correct keys on key board and make sure work is free from errors.
- Give them one hour for typing practice and evaluate their work.
- Finally share their work for correct typing and summarise the highlights.

Skill Practice	Time	Resources
1. Typing and Formatting	3 Hours	<ul style="list-style-type: none"> • News paper • Computer Systems

Unit 8.6: MS PowerPoint

Assess

At the end of the unit, students will be able to:

1. Prepare and present MS-Powerpoint.

Resources to be Used

- PowerPoint Manual
- Computer System

Do

- Greet and welcome students to the next session of the program.
- Before starting, ensure they have any doubts pertaining to the previous unit.
- Acknowledge their responses and clear their doubts if any.
- Tell them they will learn about MS Word in this unit.

Say

- Tell them about the power point. PowerPoint is the presentation graphics software in the Microsoft Office suite. PowerPoint has predefined layouts, themes, and templates to create dynamic and professional presentations.

Demonstrate

- Tell them to open MS power-point in their respective systems.
- Show them how to create a power point in MS Power-point software.
- Practically demonstrate how to perform different operations on power-point presentations
 - » Saving a Powerpoint
 - » Working with slides
 - » View tabs
 - » Animating text and Images
 - » Removing Animation
 - » Working with Charts

Notes for Facilitator



- Summarise the main points of the unit.
- Encourage students if they have any doubts. Encourage them to ask questions.
- Answer their queries satisfactorily.
- Ask them to answer the questions at the end of unit giving their own manual.
- Ensure that everyone answers all questions.

Suggestion Note: As per student give practical questions their own choice to understand the student's outcome.



- Tell them they have to prepare a power-point presentation. Powerpoint software are.
- Tell them they need to perform following operations while working on this software, Saving a Powerpoint, View tabs, Animation and Images.
- Give them one and half hour to prepare the same.
- Finally share their work for correct typing and summarise the highlights.

Skill Practice	Time	Resources
1. Presentation software	4 Hours	<ul style="list-style-type: none"> • Powerpoint Manual • Computer Lab

Unit 8.7: MS Excel

es

At the end of the unit, students will be able to:

1. Pr -Excel.

Resources to be Used

- P t Manual
- Computer System

Do

- Greet and welc ts to the next session of the program.
- Before st y have any doubts pertaining to the previous unit.
- Acknowledge their responses and clear their doubts if any.
- Tell them they will learn about Ms Excel in this unit.

Say

- MS surpass stands for - Micr excel is one of the foremost common electronic spreadsheet applica supported by both mack and computer pla rms. as with a paper spreadsheet, you'll be able to use excel to prepare your data into rows and columns and to perform mathema al calcula
- Discuss the applica ts.

Demonstrate

- Tell them to open MS Excel in their r e systems.
- Show them how to create a spread sheet in MS Ex are.
- Pr ally demonstrate how to perf erent opera cel as:
 - » Zoom in and Zoom Out
 - » Page Views
 - » Change the default excel op

- » Add Command to the quick access tool bar
- » Change the default excel op
- » Cell Addresses
- » Move Across a worksheet using key board
- » Forma
- » Calcula sis
- » Change page orienta
- » Aligning Text

Notes for Facilitator



- Summarise the main points of the unit.
- ts if they have any doubts. Encourage them to ask ques
- Answer their queries sa factorily.
- Ask them to answer the ques t the end of unit giv t's manual.
- Ensure that ever t answer all ques

Suggestive Note: As per student give pr al ques our choice to understand the student's outcome.



- T ts they have to prepare a spread sheet on MS Ex are.
- Share dat ts name, height, weight and age is given.
- Tell them they need to perform following opera while working on, Add Command to the quick access tool bar, Change the default excel op Cell Addresses, Move Across a worksheet using key board, Forma , Calcula sis, Change page orienta
- Give them one and half hour to prepare the same.
- Finally shar s for correct data typing and summarise the highligh .

Skill Pr	Time	Resources
1. Preparing Spread Sheet on MS Excel	4 Hours	<ul style="list-style-type: none"> • P t Manual • Computer Lab with MS are

Unit 8.8: Internet Concepts

Assess

At the end of the unit, students will be able to:

1. Understand the internet concepts.

Resources to be Used

- Participant Manual
- Computer with Internet

Do

- Greet and welcome participants to the next session of the program.
- Before starting, ensure participants have any doubts pertaining to the previous unit.
- Acknowledge their responses and clear their doubts if any.
- Tell them they will learn about internet concept in this unit.

Say

- Tell them about internet and its uses.
- Explain the concept of URL. The full form of url is Uniform Resource Locator. It is the worldwide address of documents and other resources on the world wide web. The URL is divided into two different elements. the primary part of the url is called a protocol identifier and the second part is called a domain name. The protocol to use.
- Now tell them about different types of URLs.

Demonstrate

- Tell them now they will learn how to open an email account in outlook.
- Demonstrate the entire process to the participants. Make sure every student should open an e-mail account.
- Now tell them how to create and send an e-mail. Explain the entire steps in detail.
- Now show them how to read an email and reply email
- Then explain an attachment. The process of attaching a file to an email.

Notes for Facilitator



- Summarise the main points of the unit.
- Check with students if they have any doubts. Encourage them to ask questions.
- Answer their queries satisfactorily.
- Ask them to answer the questions at the end of unit giving reference to the user's manual.
- Ensure that every student answers all questions.

Suggested questions to ask students:

- Ask students to explain what is Internet & what are its uses.
- Ask students to explain the concept of URL.



- Tell students they have to send emails to a friend with an attachment.
- Tell them what they need to create a word, excel or power point. They can choose between any three of the formats.
- Give 2 hours for this assignment.
- Once the assignment is complete share some screenshots of e-mail evidence with them and summarise the highlights of the assignment.

Skill Pr	Time	Resources
1. Send e-mail with a attachment	2 Hours	• Computers with Internet



Skill India
कौशल भारत - कुशल भारत



सत्यमेव जयते
GOVERNMENT OF INDIA
MINISTRY OF SKILL DEVELOPMENT
& ENTREPRENEURSHIP



N · S · D · C
National
Skill Development
Corporation

Transforming the skill landscape



9. Employability & Entrepreneurship Skills

Unit 9.1 – Personal Strengths & Value Systems

Unit 9.2 – Digital Literacy: A Recap

Unit 9.3 – Money Matters

Unit 9.4 – Preparing for Employment & Self Employment

Unit 9.5 – Understanding Entrepreneurship

Unit 9.6 – Preparing to be an Entrepreneur

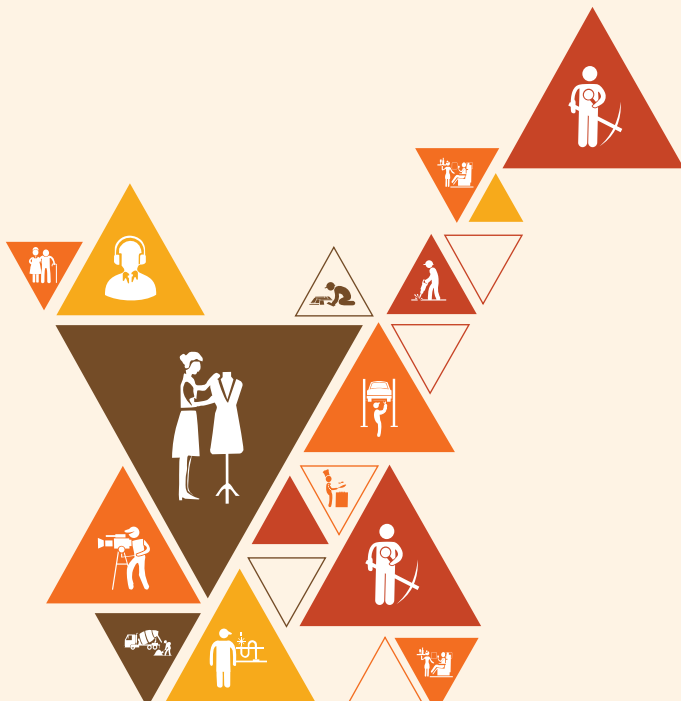

Introduction: Employability and Entrepreneurship Skills

This Facilitator's guide includes various activities which will help you as a facilitator to make the sessions participative and interactive.

Ice breaker

- You can begin the module with the following ice breaker:

Five of Anything Ice Breaker Steps:

- Divide the participants into groups of four or five by having them number off. (You do this because people generally begin a meeting by sitting with the people they already know best.)
- Tell the newly formed groups that their assignment is to share their five favourite movies of all time, their five favourite novels or their five least liked films. The topic can be five of anything - most liked or disliked.
- This ice breaker helps the group explore shared interests more broadly and sparks lots of discussion about why each person likes or dislikes their selected five.
- Tell the groups that one person must take notes and be ready to share the highlights of their group discussion with the class upon completion of the assignment.

Expectation Mapping

1. During the first session and after ice breaker session, ask the participants to answer the following question: "What do I expect to learn from this training?"
2. Have one of the participants write their contributions on a flip chart sheet.
3. Write down your own list of covered material in the training on another flip chart sheet.
4. Compare the two sheets, commenting on what will and what will not be covered during the training.
5. Set some ground rules for the training sessions. Ask the participants to put these rules on a flipchart and display it in the class.
6. You may get back to those sheets once again at the end of the last session of the training.
7. Benefits of doing this activity:
 - Participants feel better as their opinions are heard.
 - Participants get to know what they should expect from the training.
 - The facilitator gets to know which points to emphasize, which to leave out, and which to add during the training.
8. Expectations from the participants:
 - Must sign the attendance sheet when they arrive for class.
 - Conduct themselves in a positive manner
 - Be punctual, attentive, and participative
9. Explain the contents that are going to get covered one by one and connect it with the expectation mapping done earlier.
10. By the end of this exercise, the participants should have a clear understanding of what to expect from the session and what are the areas that will not get covered.

Defining Objectives

1. Defining the objectives in the beginning of the units sets the mood for the unit.
2. To begin with the end in mind sets the expectations of the participants as what could be the important takeaways from the session.
3. It is also a way of making participants take responsibility of their own learning process.
4. For the facilitator, the objectives decide a designed path to progress on so that the learning stays aligned and on track.

5. Read the objectives slowly, one by one, and ask the participants to explain what they think it means.
6. At the end of the session, you could again revisit the objectives to find out from the participants about how many objectives have been achieved.

In order to effectively facilitate this workshop:

1. You must have thorough knowledge of the material in the Participant Handbook, and be prepared to answer questions about it.
2. You may also wish to read other material to enhance your knowledge of the subject.
3. There may be issues raised with which you are not able to deal, either because of lack of time or knowledge. You can either state that you will obtain answers and get back to the participants with the information. In case the query can be turned to an assignment to the class, do so. You can work with the the participants on the assignment.
4. You must have a very clear understanding of what the participants want to accomplish by the end of the workshop and the means to guide the participants.
5. As the facilitator, it is your responsibility to make sure that all logistical arrangements are made for the workshop. This may involve doing it yourself or confirming that someone else has made all necessary arrangements associated with the workshop. Assume nothing and check everything before the workshop begins.
6. To break the monotony and boredom during sessions, introduce mini breaks in the form of stretching exercises, jokes, some group songs or games.
7. Invite discussion from the participants.
8. Probe the participants further and lead them to come to affirmative conclusions.
9. Let the participants answer. No answer is incorrect.
10. Ask one participant to write all the points on the whiteboard.
11. Build the sessions from the answers provided by the class.
12. Prepare for the sessions in advance so that the resources like flipcharts, handouts, blank sheets of paper, marker pens, etc. can be kept ready.
13. Ensure that resources like board, markers, duster etc. is available before your session starts.

General instructions for role playing:

1. You are not being asked to be an actor or to entertain. The purpose of the role play is to provide a situation in which you can practice certain skills.
2. When you read the brief, try to imagine yourself in the situation described and behave in a way you feel to be natural – but be conscious of the fact that your role may require a different approach from that which you might normally use.
3. You (and others) may benefit from the change in approach and behaviour. Therefore, try to use the approach you feel to be most appropriate for the circumstances described in your brief.
4. The brief is just the starting point. It simply sets the scene and the tone of session or activity. Try not to keep referring to the brief as this will affect the spontaneity of the meeting. Allow the role play to develop as you think it might in real life and change your reactions in line with the behaviour and responses of others involved.
5. If you find that you have too little information to answer questions or to describe what has happened in the situation, do feel free to add your own thoughts and ideas. Try to keep these within the framework of the role you are taking and try to make your improvisations as realistic as possible.

UNIT 9.1: Personal Strengths & Value Systems

Key Learning Outcomes



At the end of this unit, participants will be able to:

1. Explain the meaning of health
2. List common health issues
3. Discuss tips to prevent common health issues
4. Explain the meaning of hygiene
5. Discuss the purpose of Swacch Bharat Abhiyan
6. Explain the meaning of habit
7. Discuss ways to set up a safe work environment
8. Discuss critical safety habits to be followed by employees
9. Explain the importance of self-analysis
10. Discuss motivation with the help of Maslow's Hierarchy of Needs
11. Discuss the meaning of achievement motivation
12. List the characteristics of entrepreneurs with achievement motivation
13. List the different factors that motivate you
14. Discuss the role of attitude in self-analysis
15. Discuss how to maintain a positive attitude
16. List your strengths and weaknesses
17. Discuss the qualities of honest people
18. Describe the importance of honesty in entrepreneurs
19. Discuss the elements of a strong work ethic
20. Discuss how to foster a good work ethic
21. List the characteristics of highly creative people
22. List the characteristics of highly innovative people
23. Discuss the benefits of time management
24. List the traits of effective time managers
25. Describe effective time management technique
26. Discuss the importance of anger management
27. Describe anger management strategies
28. Discuss tips for anger management
29. Discuss the causes of stress
30. Discuss the symptoms of stress
31. Discuss tips for stress management

UNIT 9.1.1: Health, Habits, Hygiene: What is Health?

Unit Objectives

At the end of this unit, participants will be able to:

- Explain the meaning of health
- List common health issues
- Discuss tips to prevent common health issues
- Explain the meaning of hygiene
- Discuss the purpose of Swachh Bharat Abhiyan
- Explain the meaning of habit

Resources to be Used

- Participant Handbook

Ask

- What do you understand by the term “Health?”
- According to you, who is a healthy person?

Say

- Discuss the meaning of health and a healthy person as given in the Participant Handbook.

Ask

- When did you visit the doctor last? Was it for you or for a family member?

Say

- Discuss the common health issues like common cold, allergies etc. Refer to the Participant Handbook.
- Let us do a small activity. I will need some volunteers.

Role Play

- Conduct a small skit with volunteers from the class. Consider one of the villagers has been appointed as a health representative of the village, what measures will you as a health representative suggest to the common villagers to prevent common health issues discussed.
- You will need at least 4 volunteers (Narrator, Health Representative, Head of the Village, Doctor).
- Explain the health concerns of the village to the Narrator. The Narrator will brief the class about the skit.
- Give the group of volunteers, 5 minutes to do discuss.
- At the end of 5 minutes, ask the group to present the skit to the class assuming them as the villagers.
- The class can ask questions to the group as a common villager.

Summarize

- Through this activity we got some tips on how can we prevent these common health issues.

Say 

- Let us now see how many of these health standards we follow in our daily life.

Activity 

- Health Standard Checklist from the Participant Handbook.

Ask 

- How many of you think that you are healthy? How many of you follow healthy habits?

Say 

- Let's do an exercise to find out how healthy you are.
- Open your Participant Handbook section 'Health, Habits, Hygiene: What is Health?', and read through the health standards given.
- Tick the points which you think are true for you.
- Try to be as honest as possible as this test is for your own learning.

Do 

- Ensure that all the participants have opened the right page in the Participant Handbook.
- Read aloud the points for the participants and explain if required.
- Give them 5 minutes to do the exercise.
- At the end of 5 minutes, ask the participants to check how many ticks have they got.

Summarize 

- Tell them that they need to follow all the tips given in this checklist regularly in order to remain healthy and fit.

Ask **Discuss:**

- Is it necessary to practice personal hygiene every day? Why?
- How does a person feel when they do not practice good personal hygiene? Why?
- Can good personal hygiene help a person feel good about his/her self? How?

Say 

- Discuss the meaning of hygiene as given in the Participant Handbook.

Activity 

- Health Standard Checklist: Hygiene

Say

- Let's do an exercise to find out if we maintain good hygiene habits or not.
- Open the Participant Handbook and read through the Health Standard checklist given.
- Tick the points which you think are true for you.
- Try to be as honest as possible as this test is for your own learning.

Do

- Ensure that all the participants have opened the right page in the Participant Handbook.
- Read aloud the points for the participants and explain if required.
- Give them 5 minutes to do the exercise. .
- At the end of 5 minutes, ask the participants to check how many ticks have they got.
- Ask them to calculate their score.
- Tell them what each score indicates by reading aloud what has been mentioned in the Participant Handbook.

Ask

- How many of you have heard about “Swachh Bharat Abhiyan”?
- Can you tell the class what it is about?

Summarize

- Tell them about Swachh Bharat Abhiyan as given in the Participant Handbook and request them to take a pledge to keep our country clean.

Ask

- What is a habit?

Say

- Discuss some good habits which can become a way of life.

Summarize

- Tell them about good and bad habits and the reasons to make good habits a way of life.

UNIT 9.1.2: Safety

Unit Objectives

At the end of this unit, participants will be able to:

- Discuss ways to set up a safe work environment
- Discuss critical safety habits to be followed by employees

Resources to be Used

- Participant Handbook
- Safety signs and symbols
- Safety equipments
- Blank papers
- Pens

Say

- There are many common safety hazards present in most workplaces at one time or another. They include unsafe conditions that can cause injury, illness and death.
- Safety Hazards include:
 - Spills on floors or tripping hazards, such as blocked aisles or cords running across the floor.
 - Working from heights, including ladders, scaffolds, roofs, or any raised work area.
 - Unguarded machinery and moving machinery parts; guards removed or moving parts that a worker can accidentally touch.
 - Electrical hazards like cords, missing ground pins, improper wiring.
 - Machinery-related hazards (lockout/tag out, boiler safety, forklifts, etc.)

Team Activity

Safety Hazards

- There are two parts to this activity.
- First part will cover the potential safety hazards at work place.
- Second part will cover a few safety signs, symbols and equipments at work place.
- Use this format for the first part of the activity.

PART 1		
Hazard	What could happen?	How could it be corrected?

Ask

- How could you or your employees get hurt at work?

Say

- Let's understand it better with the help of an activity. You will be given a handout within your groups. You have to think about the possible hazards of your workplace, what damage these hazards could cause and about the corrective action.

Do

- Divide the class into five to six groups of four participants each.
- Put the format on the board for the activity.
- Give blank papers and pens to each group.
- The group is expected to think and discuss the potential safety hazards in the workplace.
- Ask the group to discuss and fill the format using the blank sheet.
- Give the groups 5 minutes for the activity.
- For the second part of the activity, show the class some pictures of safety signs, symbols and equipments.
- Now they will put down a few safety symbols, signs or equipment against the safety hazards identified.
- Give them 5 to 10 minutes to discuss and draw/note it.
- At the end of 10 minutes the groups will present their answers to the class.

Say

- Now, let's discuss the answers with the class.
- All the groups will briefly present their answers.

Do

- Ask the audience to applaud for the group presentation.
- Ask de-brief questions to cull out the information from each group.
- Keep a check on time.
- Tell the group to wind up the discussion quickly if they go beyond the given time limit.

Ask

De-briefing

- What did you learn from the exercise?
- As an entrepreneur, is it important to ensure the safety of your employees from possible hazards? Why?

Summarize

- Ask the participants what they have learnt so far.
- Ask if they have any questions related to what they have talked about so far.
- Close the discussion by summarizing the tips to design a safe workplace and non-negotiable employee safety habits.

UNIT 9.1.3: Self Analysis- Attitude, Achievement Motivation: What is Self Analysis?

Unit Objectives

At the end of this unit, participants will be able to:

- Explain the importance of self- analysis
- Discuss motivation with the help of Maslow's Hierarchy of Needs
- Discuss the meaning of achievement motivation
- List the characteristics of entrepreneurs with achievement motivation
- List the different factors that motivate you
- Discuss the role of attitude in self- analysis
- Discuss how to maintain a positive attitude
- List your strengths and weaknesses

Resources to be Used

- Participant Handbook
- Old newspapers
- Blank papers
- Pencils/ pens

Activity

- This is a paper pencil activity.

What are the three sentences that describe you the best?

What do you need to live happily?

What are your strengths and weaknesses?

Do

- Write the three questions on the board/ flipchart before the session begins.
- Give plain papers and pencils/ pens to each participant.
- Tell participants to write the answer for the three questions on the paper.
- Tell them the purpose of this activity is not to judge anyone but to understand more about self.

Say

- Discuss the concept of Self Analysis and motivation with reference to Maslow's Hierarchy of Needs as discussed in the Participant Handbook.

Team Activity

Tower building

- Each group which will create tower using the old newspapers.

Do 

- Divide the class into groups.
- Give them some old newspapers.
- The task is to create a tower out of the newspapers.
- The group which will create the highest tower standing on its own will be considered the winning group.
- Groups can use as many newspapers as they want to and in any way they want.

Ask 

- What did the winning group do differently?
- If you were given a chance, how would you have made the tower differently?
- How did you feel while making the tower?
- Did you feel motivated?

Say 

- Discuss the concept of achievement motivation and characteristics of entrepreneurs with achievement motivation as discussed in the Participant Handbook.

Ask 

- Is your attitude positive or negative?

Say 

- Let me tell you a story :

It's Little Things that Make a Big Difference.

There was a man taking a morning walk at the beach. He saw that along with the morning tide came hundreds of starfish and when the tide receded, they were left behind and with the morning sun rays, they would die. The tide was fresh and the starfish were alive. The man took a few steps, picked one and threw it into the water. He did that repeatedly. Right behind him there was another person who couldn't understand what this man was doing. He caught up with him and asked, "What are you doing? There are hundreds of starfish. How many can you help? What difference does it make?" This man did not reply, took two more steps, picked up another one, threw it into the water, and said, "It makes a difference to this one." What difference are we making? Big or small, it does not matter. If everyone made a small difference, we'd end up with a big difference, wouldn't we?

Ask 

- What did you learn from this story?

Activity **What Motivates You?**

- This is an individual activity.
- It is an exercise given in the Participant Handbook.

Do 

- Ask the class to open their Participant Handbook and complete the exercise given in the section What Motivates You?
- Ensure that the participants have opened the correct page for the activity.
- Give the class 5 minutes to complete the activity.

Say 

- Discuss the concept of attitude and how to cultivate a positive attitude as discussed in the Participant Handbook.

Summarize 

- Close the discussion by summarizing how self-analysis, knowledge about what motivates you and your positive attitude can help in your business as well in life.

UNIT 9.1.4: Honesty & Work Ethics

Unit Objectives

At the end of this unit, participants will be able to:

- Discuss the qualities of honest people
- Describe the importance of honesty in entrepreneurs
- Discuss the elements of a strong work ethic
- Discuss how to foster a good work ethic

Resources to be Used

- Participant Handbook

Ask

- What do you understand by honesty?
- Why is it important for entrepreneurs to be honest?
- Do you remember any incident where your honesty helped you in gaining confidence?
- Do you remember any incident where someone lost business due to dishonesty?

Say

- Talk about honesty, qualities of an honest person, and the importance of honesty in entrepreneurs as discussed in the Participant Handbook.
- “Let's understand it better with the help of some case scenarios. You will be given some cases within your groups. You have to analyse the case scenario that has been given to you and then find an appropriate solution to the problem.
- Keep your discussion focussed around the following:
 - What went wrong?
 - Who was at fault?
 - Whom did it impact- the customer or the businessman?
 - How would it impact the business immediately? What would be the long term impact?
 - What could be done?
 - What did you learn from the exercise?

Do

- Divide the class into four groups of maximum six participants depending on the batch size.
- Give one case study to each group.
- Instruct them to read the case carefully.
- Put down the de-brief questions on the board and ask the groups to focus their discussion around these questions.
- The group is expected to analyse and discuss the case amongst them and find a solution to the given problem. Give the class 5-10 minutes to discuss the case and note down their solutions.
- At the end of 10 minutes the team should present their case solution to the class. The presentation can be a narration or a role play.
- Ask the group to select a group leader for their group. The group leader to discuss and assign roles to the group members for the presentation.

Team Activity

Case Study Analysis

Scenario 1

Aakash has a small mobile retail sales and repair shop in Allahabad. He has one of the most popular outlets and has great rapport with his customers.

It's around 11 AM when a customer barges in to the shop and starts shouting at Aakash for giving her a faulty instrument. The screen of her mobile is cracked from one side. Aakash remembered thoroughly checking the handset before handing it over to the customer. The customer threatens to sue him and to go to Consumer Court for cheating her. Now, the problem occurred somewhere outside the shop but as other customers were listening to the conversation, it might impact his business. The situation needs to be managed very sensitively. What would you do if you were in Aakash's place?

Scenario 2

Rajni does beautiful Phulkari embroidery on suits and sarees. She has a small home-based business. She has a huge list of customers on Facebook and WhatsApp who give her orders regularly. Smita is one of her old and regular customers. As her sister-in-law's wedding was around the corner, Smita wanted to buy few handcrafted Phulkari duppatta. She placed an order for three duppattas via WhatsApp and requested Rajni to send them as soon as possible. When the parcel reached Smita through courier she found that out of the three duppattas, only one was hand embroidered and the other two had machine embroidery on them. Even the length and the quality of the material was not as desired. Smita was heartbroken. It was a complete waste of money and moreover she couldn't wear what she had planned to during the wedding functions. She sent a message to Rajni on WhatsApp, expressing her anger and disappointment.

Smita has also sent a feedback and expressed her disappointment on the social media... this will directly affect Rajni's business. What would you do if you were in Rajni's place?

Scenario 3

Shankar is a tattoo artist who has a small tattoo showroom in a big, reputed mall in New Delhi. Mr Saksham had an appointment for today, at 11:00 am but he reached at 11:50 am. Meanwhile, Shankar had to reschedule his next appointment. After availing Shankar's services, Mr Saksham started yelling in an abusive language, refusing to pay the requisite amount, and finding faults in the services provided by him. Who was at fault in this case? What should Shankar do? Should he confront Saksham or give in to the demands of the client?

Scenario 4

Shailender is an online cloth reseller who does business through social networking sites such as Facebook and WhatsApp. Priyanka made online payment for a dress to Shailender. But she did not receive the dress for a month. When she asked for a cancellation, Shailender started misleading her. For almost 45 days, he kept promising her that he will pay the amount today, tomorrow, day after etc. Even after repeated calls and messages when she did not receive the payment or the dress, she decided to write a post against him on a popular social media platform. As a result, Shailender lost lots of customers and his flourishing business faced a major crisis. How could this situation have been managed?

Say

- Now, let's discuss the problem and solution with the larger group.
- The group will first briefly describe the case to the class.
- Then discuss the issue identified and the proposed solution.
- Once the presentation is over, the class can ask their questions.

Do 

- Congratulate each group for the group presentation.
- Ask the audience to applaud for them.
- Ask de-brief questions to cull out the information from each group.
- Keep a check on time. Tell the group to wind up the discussion quickly if they go beyond the given time limit.

Summarize 

- Ask the participants what they have learnt from the exercise/ activity.
- Ask if they have any questions related to what they have talked about so far.
- Close the discussion by summarizing the importance of honesty and work ethics for entrepreneurs.

UNIT 9.1.5: Creativity and Innovation

Unit Objectives

At the end of this unit, participants will be able to:

- List the characteristics of highly creative people
- List the characteristics of highly innovative people

Resources to be Used

- Participant Handbook
- Chart papers
- Marker pens

Ask

- You must be aware of the term 'Rags to riches' and heard stories related to the term.
- What do these stories tell us?
- What was so special about these people?

Say

- Let's have a look at these stories.
- There are some inspiring stories about people which I would like to share with you.
- Narrate these stories to the class.

A.P.J. Abdul Kalam

Who has not heard of A.P.J. Abdul Kalam: Avul Pakir Jainulabdeen Abdul Kalam hailed from a very humble background. His father was a boat owner. To help his family, Kalam would work as a newspaper vendor. With limited resources, he graduated in Physics and studied aerospace engineering. He was instrumental in India's step towards nuclear energy. In 2002, he became the 11th President of India.

Water filter/purifier at source

Two young boys studying in classes 4 and 5, from Lingzya Junior High School, Sikkim designed a simple innovative low cost water purifier.

Inspiration behind the idea: Most people today prefer to use a water filter/purifier at their home.

Both the children have given idea to have filter/purifier at the source of water so that everyone has access to clean water without having to make an investment in purchasing a filter/purifier.

Spring's idea is to have a centralised purification system at the point of distribution like water tank while Subash's idea is to have such purifiers attached to public taps.

Source: <http://www.rediff.com/getahead/report/achievers-top-31-amazing-innovations-from-young-indians/20151208.htm>

Solar seeder

This is a story of a innovative solar seeder and developed by Subash Chandra Bose, a class 8, student from St Sebasthiyar Matriculation School, Pudukkottai, Tamil Nadu. Subash has developed a solar powered seed drill, which can undertake plantation for different size of seeds at variable depth and space between two seeds.

Source: <http://www.rediff.com/getahead/report/achievers-top-31-amazing-innovations-from-young-indians/20151208.htm>

Looms for physically challenged

Now this is really inspiring of two sisters, Elakkiya a Class 6 student and Pavithra a Class 9 student of SRC Memorial Matriculation, Erode, Tamil Nadu.

The two sisters have come up with loom for lower limbed physically challenged. In their loom they have replaced the pedal operated system with a motor and a gearbox attached to a pulley mechanism.

Source: <http://www.rediff.com/getahead/report/achievers-top-31-amazing-innovations-from-young-indians/20151208.htm>

Ask 

- If they can, why can't you?
- Discuss concepts related to 'Creativity and Innovation' with the participants as given in the Participant Handbook.

Say 

- Recall the stories on motivation.
- What is the inner drive that motivates people to succeed?
- Let's learn more about such creative and innovative entrepreneurs with the help of an activity.

Team Activity 

- This is a group activity.

- Think of any one famous entrepreneur and write a few lines about him or her.

Activity De-brief

- Why did you choose this particular entrepreneur?
- What is his/her brand name?
- What creativity does he/she possess?
- What was innovative about their ideas?

Do 

- Instruct the participants that this is group work.
- Divide the class into small groups of 4 or 6 depending on the batch size.
- Give each group a chart paper.
- Tell the participants they have to write a few lines about any one famous entrepreneur.
- Give the participants 10 minutes to discuss and write.
- Keep a check on time. Tell the group to wind up quickly if they go beyond the given time limit.
- Ask each group to read out what they have written.
- Ask the de-brief questions.

Summarize

- Summarize the unit by asking participants if they know of some people who are highly creative and innovative in their approach.
- Ask them to share some experiences about these people with the class.

Notes for Facilitation

- Source for stories on innovations:

<http://www.rediff.com/getahead/report/achievers-top-31-amazing-innovations-from-young-indians/20151208.htm>

UNIT 9.1.6: Time Management

Unit Objectives

At the end of this unit, participants will be able to:

- Discuss the benefits of time management
- List the traits of effective time managers
- Describe effective time management techniques

Resources to be Used

- Participant Handbook

Ask

Does this sound like you?

- I can never get enough time to finish what I am doing in a day.
- I have so many things to do that I get confused.
- I want to go for a walk and exercise, but I just do not have the time.
- I had so much to do, so I could not deliver that order on time.
- I would love to start my dream business; but, I just do not have the time.

Example

- Let's look at these two examples:

Example 1:

Ankita works from home as a freelance writer. She says she can easily put in 8 hours of dedicated work in a day. Because she works from home, she saves money on travel and has a comfortable work routine. But there is a challenge and it is distraction. As she works from home, she can easily just get up and sit down on the sofa to watch TV, wasting valuable time. She may have chores to do, errands to run and bills to pay. She ends up working only two to three hours a day and the result is, her work gets piled up. She is unable to take on more work due to this. Even though her quality of work is appreciated her clients are not very happy about the delay in submission.

Example 2:

Javed has started a successful online selling company from home and makes a good living from his sales. He has set up a small office space in his living room. As both his parents are working full-time, he also has the role of taking care of his two younger siblings. He almost spends half of his day with the younger kids. He does not mind it but it means taking time away from the work. He is still able to manage his online business with these commitments. He wants to spend some more dedicated hours so as to increase his profits. He also wants to look into new business avenues. What should he be doing.

Ask

- Does this happen with you too?
- Do you find it difficult to prioritize your work?
- Are you able to manage your time effectively?

Activity



- Conduct a group discussion based on the above examples.
- Direct the discussion on how to prioritize work and manage time effectively.

Say



- Time management is not only about how hard you work but also about how smart you work.
- Discuss “What is Time Management” with the participants as given in the Participant Handbook.

Ask



- Why is it important to manage time? How does it help?
- What happens when you don't manage your time effectively?
- Do you find it difficult to prioritize your work?

Say



- Discuss the benefits of time management given in the Participant Handbook.
- Let's learn effective time management with the help of an activity.

Activity



Effective Time Management

- This activity has two parts:

PART 1 TO-DO LIST

- You have to make a to-do list.
- List all of the activities/ tasks that you have to do.
- Try to include everything that takes up your time, however unimportant it may be.
- If they are large tasks, break them into action steps, and write this down with the larger task.
- You can make one list for all your tasks or have separate to-do lists for personal and professional tasks.

PART 2 URGENT-IMPORTANT GRID

- You have to make a grid as shown on the board here. .
- This grid has four boxes. As you can see, each box has a different heading.
- At the heart of the urgent-important grid, are these two questions:
 - ♦ Is this task important?
 - ♦ Is this task urgent?
- Now, you have to think about each activity that you have written in your to-do list and put it into one of the four categories.
- **What do these categories depict?**
- **Category 1: Urgent/Important**
 - ♦ This category is for the highest priority tasks. They need to get done now.

- **Category 2: Not Urgent/Important**
 - This is where you want to spend most of your time.
 - This category allows you to work on something important and have the time to do it properly.
 - This will help you produce high quality work in an efficient manner.
 - The tasks in this category are probably the most neglected ones, but also the most crucial ones for success.
 - The tasks in this category can include strategic thinking, deciding on goals or general direction and planning – all vital parts of running a successful business.
- **Category 3: Urgent/Not Important**
 - This is where you are busy but not productive. These tasks are often mistaken to be important, when they're most often busywork.
 - Urgent but not important tasks are things that prevent you from achieving your goals.
 - However, some may be activities that other people want you to do.
- **Category 4: Not Important and Not Urgent**
 - This category doesn't really include tasks, but rather habits that provide comfort, and a refuge from being disciplined and rigorous with your time management.
 - Some may be activities that other people want you to do.
 - These might include unplanned leisure activities as well.

TO- DO list format

1.	
2.	
3.	
4.	
5.	
6.	
7.	
8.	
9.	
10.	
11.	
12.	
13.	
14.	
15.	

URGENT-IMPORTANT GRID

URGENT/ IMPORTANT

- Meetings
- Last minute demands
- Project deadlines
- Crisis

NOT URGENT/ IMPORTANT

- Planning
- Working towards goals
- Building relationship
- Personal commitments

1

2

3

4

- Interruptions
- Phone calls/ E-mails
- Other people's minor demands

URGENT/ NOT IMPORTANT

- Internet surfing
- Social media
- Watching TV

NOT URGENT/ NOT IMPORTANT

URGENT/ IMPORTANT GRID format

URGENT/ IMPORTANT

NOT URGENT/ IMPORTANT

1

2

3

4

URGENT/ NOT IMPORTANT

NOT URGENT/ NOT IMPORTANT

Do

- Put down the formats for the to-do list and the urgent/important grid on the board.
- Instruct the participants to prepare their to-do list first.
- Give the participants 10 minutes to prepare the list.
- Once done, instruct them to divide the tasks in to-do list into the four categories.
- Explain the four categories to the participants giving examples specific to their context.
- As you explain the categories fill the grid with the type of tasks.
- Give the participants 40 minutes to fill the grid.
- Then explain how to balance the tasks between the four categories.
- Keep a check on time. Tell the group to wind up quickly if they go beyond the given time limit.

Say

Activity De-brief:

How can we balance tasks between the four categories?

How to manage time through this grid?

- **Category 1: Urgent/Important**
 - ♦ Try to keep as few tasks as possible here, with the aim to eliminate.
 - ♦ If you spend too much of your time in this category, you are working solely as a trouble shooter, and never finding time to work on longer-term plans.
- **Category 2: Not Urgent/Important**
 - ♦ Plan these tasks carefully and efficiently as they are most crucial ones for success.
 - ♦ If necessary, also plan where you will do these tasks, so that you're free from interruptions.
 - ♦ Include strategic thinking, deciding on goals or general direction and planning in your planning process.
- **Category 3: Urgent/Not Important**
 - ♦ Ask yourself whether you can reschedule or delegate them.
 - ♦ A common source of such activities is other people. Sometimes it's appropriate to say "no" to people politely, or to encourage them to solve the problem themselves.
- **Category 4: Not Important and Not Urgent**
 - ♦ You also want to minimize the tasks that you have in this category.
 - ♦ These activities are just a distraction – avoid them if possible.
 - ♦ You can simply ignore or cancel many of them.
 - ♦ Politely say "no" to work assigned by others, if you can, and explain why you cannot do it.
 - ♦ Schedule your leisure activities carefully so that they don't have an impact on other important tasks.
- Discuss the traits of effective time managers and effective time management techniques as given in the Participant Handbook.

Summarize

- Discuss the traits of effective time managers and effective time management techniques as given in the Participant Handbook.

Notes for Facilitation



- Here is a short story. You can conclude the session narrating the story. To make it more interesting you can perform the demonstration described and discuss the short story.
 - ♦ One day an expert in time management was speaking to a group of students. As he stood in front of the group, he pulled out a large wide-mouthed glass jar and set it on the table in front of him. Then he took out a bag of about a dozen rocks and placed them, one at a time, into the jar. When the jar was filled to the top and no more rocks would fit inside, he asked, "Is this jar full?" Everyone in the class said, "Yes." Then he said, "Really?"
 - ♦ He reached under the table and pulled out a bucket of gravel (small stones). He dumped some gravel in and shook the jar causing pieces of gravel to work themselves down into the space between the rocks. Then he asked the group once more, "Is the jar full?" By this time, the class began to understand. "Probably not," one of them answered. "Good!" he replied.
 - ♦ He reached under the table and brought out a bucket of sand. He started dumping the sand in the jar and it went into all of the spaces left between the rocks and the gravel. Once more he asked the question, "Is this jar full?" "No!" the class shouted. Once again he said, "Good." Then he grabbed a jug of water and began to pour it in until the jar was filled to the brim. Then he looked at the class and asked, "What is the point of this illustration?" "One student raised his hand and said, "No matter how full your schedule is, if you try really hard you can always fit some more things in it!" "No," the speaker replied, "that's not the point. The truth this illustration teaches us is: If you don't put the big rocks in first, you'll never get them in at all." What are the 'big rocks' in your life? Your children; your loved ones; your education; your dreams; a worthy cause; teaching or mentoring others; doing things that you love; time for yourself; your health; your mate (or significant other). Remember to put these BIG ROCKS in first or you'll never get them in at all. If you sweat about the little stuff (the gravel, sand, and water) then you'll fill your life with little things you worry about that don't really matter, and you'll never have the time you need to spend on the big, important stuff (the big rocks).
- End the story with these lines...

So, tonight, or in the morning tomorrow, when you are reflecting on this short story, ask yourself this question: What are the 'big rocks' in my life? Then, put those in your jar first

UNIT 9.1.7: Anger Management

Unit Objectives

At the end of this unit, participants will be able to:

- Discuss the importance of anger management
- Describe anger management strategies
- Discuss tips for anger management

Resources to be Used

- Participant Handbook

Ask

- What is anger? Is anger good or bad?
- Is anger normal or an abnormal behaviour? How can anger harm you?
- Why is it important for entrepreneurs to manage their anger?

Say

- Talk about anger and the importance of anger management in entrepreneurs as discussed in the Participant Handbook.
- Let us do a small activity. This is an individual activity.
- Think of the incidents and situations that angered you and hurt you.

Do

- Instruct them to note down these situations under different categories (as given in the Activity).
- Give the class 3-5 minutes to think and note down their answers.
- At the end of 5 minutes, ask some participants to volunteer and present their answers.
- They can also share these situations with their fellow participants if they do not wish to share it with the entire class.

Activity

- Do you remember any incident which has hurt
 - ♦ you physically
 - ♦ you mentally
 - ♦ your career
 - ♦ your relationships.

Ask

- Do you ever get angry?
- What are the things that make you angry?
- Do you remember any incident where your anger management helped you in maintaining healthy relationship?
- Do you remember any incident where someone lost business/ friend/ relationship due to temper (anger)?

Say

- There are a few strategies which can help in controlling your anger. Let's do an activity to understand the anger management process better.
- This is an individual activity.
- Think of the incidents/ situations which trigger your anger (the cause).
- Then think what happened as a result of your anger (the effect).
- You need to come up with some techniques to manage your anger.

Do

- Give the class the anger triggers (the cause) as listed in the activity.
- Put down the activity format (Anger Triggers, Result of your Anger, Anger Management Techniques) on the board and instruct the class to write the answers under different categories.
- Give the class 3-5 minutes to think and note down their answers.
- At the end of 5 minutes, ask the participants who wish to volunteer and present their answers.

Activity

Trigger points and Anger Management Techniques Activity

Anger Triggers

List of triggers that make you angry:
Someone says you did something wrong.
You want something you can't have now.
You get caught doing something you shouldn't have been doing.
You are accused of doing something you didn't do.
You are told that you can't do something.
Someone doesn't agree with you.
Someone doesn't do what you tell him to do.
Someone unexpected happens that messes up your schedule.

Result of your anger:

--

Write the techniques that you use to manage your anger:

Anger Management Techniques

Say

- Now, let's discuss the problems and solution with all.
- The individual will first briefly describe trigger points to the class.
- Then discuss the result of the anger. Other participants are requested to remain quiet while one is making the presentation.
- Post presentation, other participants may ask questions.

Do

- Congratulate each individual for sharing their points.
- Ask the audience to applaud for them.
- Ask de-brief questions after the presentation to the class.
- Keep a check on the time. Ask the participants to wind up the activity quickly if they go beyond the given time limit.

Ask

De-brief questions:

- In the situation described by the presenter, who was at fault?
- How could you have handled this situation alternatively?

Summarize

- Close the discussion by summarizing the strategies and tips of anger management for entrepreneurs.
- Ask the participants what have they learnt from this exercise/ activity.
- Ask if they have any questions related to what they have talked about so far.

Notes for Facilitation

- Encourage the participants to share information about them while presenting the situations to the class.
- Keep the format of the Activity prepared in a chart paper so that it can be displayed during the session.

UNIT 9.1.8: Stress Management: What is stress?

Unit Objectives

At the end of this unit, participants will be able to:

- Discuss the causes of stress
- Discuss the symptoms of stress
- Discuss tips for stress management

Resources to be Used

- Participant Handbook

Ask

- You are waiting in the reception for an interview or a very important meeting, suddenly your legs are shaky, your hands are cold, you are feeling nervous. Have you ever been in this kind of situation?
- Have you had days when you had trouble sleeping?
- Have you ever been so worried about something that you ended up with a terrible headache?

Say

- You've probably heard people say, "I'm really stressed out" or "This is making me totally stressed."

Ask

- What do you understand by stress?
- What gives you stress?
- How do you feel when you are stressed or what are the symptoms of stress?
- How can stress harm you?
- Why is it important for entrepreneurs to manage stress?

Say

- When we feel overloaded or unsure of our ability to deal with certain challenges, we feel stressed.
- Discuss about stress, causes of stress, and symptoms of stress as discussed in the Participant Handbook.
- Let's understand the causes of stress and how to deal with them with the help of some case scenarios.
- You will be given some cases.
- You have to analyse the case scenario and then find an appropriate solution to the problem.
- This will be a group activity.

Do

- Divide the class into four groups of 5-6 participants (depending on the batch size).
- Assign one case scenario to each group.
- Instruct them to read the case carefully.
- The group is expected to analyse and discuss the case amongst them and find a solution to the given problem.
- Explain their discussion should result in getting answers for the following questions:

- ♦ What was/ were the cause(s) of stress?
- ♦ Was the stress avoidable or manageable under the given circumstances?
- ♦ If yes, how do you think that the stress could be avoided (managed)?
- ♦ If no, then why not?
- Give the class 10-12 minutes to discuss the case and note down their solutions.
- At the end of 12 minutes, the team should present their case solution to the larger group.
- Ask the group to select a group leader for their group.
- The group leader to discuss and assign roles to the group members for the presentation.

Team Activity

Case Study Analysis

Scenario 1

Akash's alarm doesn't go off and he gets late getting out of the house. He hits traffic and ends up 15 minutes late to work, which his boss notices. He gets to his desk and finds he has to complete 2 reports in next one hour. Just when he is about to begin work, a message pops up "Telecon with the client begins in 10 minutes. Please be in the conference room in 5 minutes."

His is not prepared for the call. He is stressed. He does not want to speak to his boss about this. He is stressed, feeling uncomfortable and sick. Not in a position to attend the call or finish the reports on time.

Scenario 2

While paying his overdue bills, Rahul realised that it's the middle of the month and he has only Rs 500 left in his account. He has already asked all of his friends, and family for loans, which he hasn't paid back yet. He is still contemplating over the issue when his phone rings. His sister's birthday is due next week and she has seen a beautiful dress which she wants to buy but cannot tell the parents as it is a bit expensive. She wishes if Rahul could buy the dress for her. Rahul has promised to buy her the dress for her birthday.

Rahul is stressed, does not understand what to do. He is unable to concentrate on his work and unable to complete the tasks assigned. His team leader has already warned him of the delay.

Scenario 3

Sheela calls the cable company as she has unknown charges on her bill. She has to go through the automated voice mail menu three times and still can't get through to a customer care executive. After 15 minutes of repeated efforts, her call is answered. She explains the entire issue to the customer care executive but before the person could suggest a way out, the call drops.

Now Sheela has to call back and repeat the whole process all over again with a new customer care executive. She is very angry and calls again but cannot connect this time.

She has to leave to office so she decides to call from office and check. When she connects this time she is angry and argues with the executive on the call. All her co-workers around are looking at her as her volume has suddenly increased. She bangs the phone and ends the call.

Her co-worker Neelam enquires what has happened to her. She ignores her and just walks off. She has become irritable and her behaviour and tone with other co-workers is not acceptable.

Scenario 4

Arpit is a young entrepreneur who started doing business through Facebook few weeks back. He had always been into a job. Although Arpit has very few financial liabilities, it wasn't an easy decision to leave a comfortable job at once and look for newer pastures. Arpit's boss warned him of the consequences and the challenges of starting a business when nobody ever in his family had been in business.

He has not been able to get a good deal till now. This is an important life shift for him which comes with unknown variables. Arpit is nervous and is wondering if he has what it takes to fulfill the requirement of his new role, or the new experiences he's likely to face.

Ask**De-brief questions:**

- What was/ were the cause(s) of stress?
- Was the stress avoidable or manageable under the given circumstances?
- If yes, how do you think that the stress could be avoided (managed)?
- If no, then why not?

Say

- Now, let's discuss the problem and solution with the larger group.
- The group will first briefly describe the case to the class.
- Then discuss the issue identified and the proposed solution.
- Post presentation, the other groups may ask questions to the group that has presented.

Do

- Congratulate each group for sharing their points.
- Ask the audience to applaud for them.
- Ask de-brief questions to cull out the information from each group.
- Keep a check on time. Tell participants to wind up the discussion quickly if they go beyond the given time limit.

Say

- While it is common and normal to feel some tension. This feeling nervous and tensed can interfere with your thinking process and can have a negative impact on your performance.
- Stress can deplete the most vibrant of souls. It can have a negative effect on every aspect of a person's life including their health, emotional well-being, relationships, and career. However, one needs to understand the causes and types of stress before looking for ways to manage it.

De-brief:**Scenario 1**

The cause of stress was lack of time management and the habit of procrastinating. If Akash would have managed his time well, planned alternate ways to get up on time, finished prior tasks on time and planned for client meetings in advance then he wouldn't have faced stress.

Scenario 2

The cause of stress was lack of financial planning. Rahul should have planned his financial resources well in advance and saved some money for the rainy day. Also, differentiating between needs and wants and keeping a check on non-essential expenditure would have saved Rahul from this situation.

Scenario 3

Sometimes, stress is caused due to external factors instead of internal ones. In this case, the stress was unavoidable because we have no control over this customer care system. Every time, you will get in touch with a new executive and will have to explain all over again. This might cause stress but despite being frustrated and angry there is little that we can do about it. All Sheela could do was to find ways to calm herself down through some breathing exercises and meditation, reading some good book or listening to music and then start afresh.

Scenario 4

A positive, major life change can be a source of good stress. Regardless of how good the change is, it can be stressful. Stress caused by a positive and major life change can be beneficial because it causes a person to step out of their comfort zone and learn new skills. Here, Arpit may become a successful entrepreneur or learn new ways to do things differently.

Now let us see this scenario, can I have a volunteer to read out this case to the class.

Do 

- Ask one of the participant who can volunteer and read out this scenario to the class.

Scenario 5

Rakesh lives in Kathmandu with his wife and two beautiful daughters Sarah and Sanya. Nepal was hit by a massive earthquake and Rakesh's building collapsed during the earthquake. During evacuation, Rakesh realised that though his wife and Sarah were fine and suffered only minor bruises, Sanya was nowhere in the scene. Panic stricken, he started calling her name and searching her frantically. A little later, he heard a meek voice from beneath the debris. He quickly removed the rubble to find a huge bed. Rakesh was pretty sure that Sanya was trapped underneath. Though he was badly bruised, he gathered all his courage and with all his might, he lifted the several-ton bed to save Sanya's life. Everyone was relieved to see Sanya alive and also extremely surprised to see this father's ability to access superhuman strength.

- Ask the audience to applaud for the participant after the scenario is read completely.
- Discuss the scenario, ask de-brief questions:
 - ♦ What kind of stress was Rakesh undergoing in this case?
 - ♦ Was the stress avoidable or manageable under the given circumstances?
 - ♦ What was the result of the stress?

Say **De-brief:**

- Not all stress is harmful; good stress is actually energizing. This was a case of lifesaving stress, or hero stress, which is an important example of good stress. You may have heard stories in which a person performs an impossible feat of physical strength in order to save their life or the life of someone they love. This type of stress causing a surge of adrenaline is good for us.

Summarize



- Close the discussion by summarizing the tips to manage stress as given in the Participant Handbook.
- Ask the participants what they have learnt from this exercise/ activity.
- Ask if they have any questions related to what they have talked about so far.

Notes for Facilitation



- Keep printed copies of the activities/ scenarios ready for the session.
- Put down the de-brief questions on a flip chart so that it can be displayed in the class during the activity.
- Encourage participation and make the discussions interactive.

UNIT 9.2: Digital Literacy: A Recap

Key Learning Outcomes



At the end of this unit, participants will be able to:

1. Identify the basic parts of a computer
2. Identify the basic parts of a keyboard
3. Recall basic computer terminology
4. Recall the functions of basic computer keys
5. Discuss the main applications of MS Office
6. Discuss the benefits of Microsoft Outlook
7. Identify different types of e-commerce
8. List the benefits of e-commerce for retailers and customers
9. Discuss Digital India campaign will help boost e-commerce in India
10. Describe how you will sell a product or service on an e-commerce platform

UNIT 9.2.1: Computer and Internet Basics: Basic Parts of a Computer

Unit Objectives

At the end of this unit, participants will be able to:

- Identify the basic parts of a computer
- Identify the basic parts of a keyboard
- Recall basic computer terminology
- Recall the functions of basic computer keys

Resources to be Used

- Participant Handbook
- Computer Systems with the required applications

Say

- Let's take a quick recap of the basic computer parts.
- Discuss 'Basic Parts of Computer' and 'Basic Parts of a Keyboard' with the class as given in the Participant Handbook.

Explain

- Explain all the parts of the computer and the keyboard by demonstrating on the real system.

Ask

- Do you know about internet?
- Have you ever used internet?
- Why do you think internet is useful?
- What was the last task you performed on internet?

Say

- Let's look at some basic internet terms.
- Discuss 'Basic Internet Terms' with the participants as given in the Participant Handbook.

Summarize

- Ask the participants what they have learnt from this exercise/ activity.
- Ask if they have any questions related to what they have talked about so far.
- Close the discussion by summarizing the importance of computer and internet for entrepreneurs.

Practical

- Conduct a practical session.
- Ask the participants to assemble in the computer lab.
- Give some hands on practice exercises.

Do

- Group the participants for the activity depending on the batch size and the number of computer systems available in the lab.
- Explain the purpose and duration of the activity.
- Ensure the participants complete the practical exercises assigned.

UNIT 9.2.2: MS Office and Email: About MS Office

Unit Objectives

At the end of this unit, participants will be able to:

- Discuss the main applications of MS Office
- Discuss the benefits of Microsoft Outlook

Resources to be Used

- Participant Handbook
- Computer Systems with MS Office

Ask

- What is the most frequent activity that you do on the computer?
- Do you know how to make presentations on the computer?

Say

- Give a brief introduction of MS Office as given in the Participant Handbook.
- Discuss the most popular office products. Explain in brief their application, benefits and working.
- **Microsoft Word** is a word processing program that allows for the creation of documents. The program is equipped with templates for quick formatting. There are also features that allow you to add graphics, tables, etc.
- **Microsoft Excel** is a tool for accounting and managing large sets of data. It can also simplify analysing data. It is also used to create charts based from data, and perform complex calculations. A Cell is an individual data box which will have a corresponding Column and Row heading. This gives the cell a name, referred to as the Cell Reference. There can be multiple pages in each workbook. Each page, or sheet, is called a Worksheet. When you open a new Excel file, it automatically starts you with three worksheets, but you can add more.

Explain

- Explain the working and frequently used features of Office on a real system.

Ask

- What do you know about e-mails?
- Do you have an email id?
- How often do you check your e-mails?

Say

- Communication is vital for every business. The fastest and the safest way to communicate these days are through emails. MS Outlook helps to manage your emails in a better way and also offers a host of other benefits.
- Discuss “Why Choose Microsoft Outlook?” with the participants as given in the Participant Handbook.

Do 

- Ask the participants to assemble in the computer lab.
- Explain the working of Outlook on a real system..

Demonstrate 

- Demonstrate how to create email id.
- Demonstrate how to write new mails, send mails.
- Demonstrate how to use MS Office application to create a letter and send it as attachment in an email.
- Demonstrate how to use other MS Office applications.

Practical 

- Give some hands on practice exercises
- Group the participants for the activity depending on the batch size and the number of computer systems available in the lab.
- Explain the purpose and duration of the activity.

Summarize 

- Ask the participants what they have learnt from this exercise/ activity.
- Ask if they have any questions related to what they have talked about so far.

UNIT 9.2.3: E-Commerce

Unit Objectives

At the end of this unit, participants will be able to:

- Identify different types of e-commerce
- List the benefits of e-commerce for retailers and customers
- Discuss Digital India campaign will help boost e-commerce in India
- Describe how you will sell a product or service on an e-commerce platform

Resources to be Used

- Computer System with internet connection
- Participant Handbook

Ask

- How many of you have done shopping online?
- Can you name at least five shopping websites?
- What is the product that you most frequently buy online?
- Why do you do shopping online instead of going to the market?

Say

- Give a brief introduction of “What is E-commerce”. Refer to the Participant Handbook.
- E-commerce emerged in the early 1990s, and its use has increased at a rapid rate. Today, many companies sell their products online. Everything from food, clothes, entertainment, furniture and many other items can be purchased online.

Ask

- What other types of transactions have you performed on the internet other than buying products?

Say

- Give examples of e-commerce activities from Participant Handbook.

Team Activity

E-commerce examples

- Instruct the participants to list some of the payment gateways that they have used for e-commerce activities.
- Give them 5 minutes to make this list.
- Discuss payment gateways and transaction through payment gateways.
- Conclude the discussion by mentioning how important e-commerce has become in our day to day transactions.

Say

- E-commerce activities can be classified based on the types of participants in the transaction.
- Discuss “Types of E-commerce” from the Participant Handbook.

Do

- Discuss all types of E-commerce by giving examples and names of some popular websites which use them.
- Make the discussion interactive by asking the class to share some popular e-commerce sites of each type.

Say

- E-commerce activities bring a host of benefits for both, retailers and customers.
- Discuss benefits of E-commerce from the Participant Handbook.

Explain

- The majority of the population that uses E-commerce activities lives in tier-1 and tier-2 cities. To encourage the use of digital money in tier-3 and 4 areas, PM Mr. Modi launched the “Digital India Campaign”.
- Discuss “Digital India Campaign” from the Participant Handbook.
- By Digital India project the government will deliver services via mobile connectivity and in doing so, is expected to bring the internet and broadband to remote corners of the country. This connectivity will in turn enhance e-commerce activities also. Furthermore, the Indian Government is also modernizing India Post and aims to develop it as a distribution channel for e-commerce related services.

Say

- Now let us discuss how to sell a product using E-commerce.
- Every product has to be sold on a platform on the internet. Think of it as a shop that you have to sell your product. Now this shop can be your own or shared or rented. If the shop is your own or rented there will be only your products in that shop. If the shop is shared, there will be products of multiple sellers in that shop. A common example is a departmental store which has products from multiple brands in the shop.
- Similarly, in E-commerce the shop is the website where your products are displayed. If it is your own website it will exclusively showcase your products. In this case the cost that you will incur will be:
 - ♦ Developing the website
 - ♦ Hosting the website
 - ♦ Maintenance of the website
- If you rent a website it will also showcase your own products but the development, hosting and maintenance parts goes to the owner. This saves time and the cost to manage these activities.
- Smaller companies usually go for renting a website and the bigger ones develop their own website.
- The concept of shared platforms has become very popular in recent times. In this platform the sellers have to register and then they can sell their goods on a common platform. Among the most popular of these are Amazon, Myntra, Flipkart, etc.

Role Play

- Tell the participants to choose a product or service that they want to sell online.
- Tell them to write a brief note explaining how they will use existing e-commerce platforms, or create a new e-commerce platform to sell their product or service.

Ask 

- How much money are you carrying in your wallet?
- Do you have a credit/debit card?
- How do you make payments while doing online shopping?

Say 

- Demonetization has made carrying cash in the wallet very difficult. People either shop through cards or some other form of digital money.
- So what do you think is digital money?
- In this form the money is both paid and received digitally. There is no hard cash involved. It is an instant and convenient way to make payments.
- There are various types of digital payments. Let us discuss some of them in brief here.
- The first one is the most commonly used system i.e. the cards. Debit card, credit card, prepaid card, all fall under this category.
- Then is the e-wallet or the mobile wallet. This has become the most used form of digital money after demonetization. Examples are Paytm, state bank buddy, Freecharge, etc.
- Many other forms of digital money are also coming up in market like mobile apps, Aadhar card based payment, etc.

Do 

- Demonstrate how to make and receive payments through digital models like Paytm and state bank buddy.

Ask 

- Why do you think people have started using digital money instead of hard cash? Is demonetization the only reason?

Say 

- Digital money gives a lot of advantages over the conventional hard cash. Some of them are:
 - ♦ Digital payments are easy and convenient. You do not need to take loads of cash with you, a mobile phone or a card will suffice.
 - ♦ With digital payment modes, you can pay from anywhere anytime.
 - ♦ Digital payments have less risk.

Summarize 

- Ask the participants what they have learnt from this exercise/ activity.
- Ask if they have any questions related to what they have talked about so far.
- Close the discussion by summarizing the importance of e-commerce and digital money.

UNIT 9.3: Money Matters

Key Learning Outcomes



At the end of this unit, participants will be able to:

1. Discuss the importance of saving money
2. Discuss the benefits of saving money
3. Discuss the main types of bank accounts
4. Describe the process of opening a bank account
5. Differentiate between fixed and variable costs
6. Describe the main types of investment options
7. Describe the different types of insurance products
8. Describe the different types of taxes
9. Discuss the uses of online banking
10. Discuss the main types of electronic funds transfer

UNIT 9.3.1: Personal Finance – Why to Save?

Unit Objectives

At the end of this unit, participants will be able to:

- Discuss the importance of saving money
- Discuss the benefits of saving money

Resources to be Used

- Participant Handbook

Ask

- How many of you save money?
- Why do you feel the need to save it?
- Do you plan your savings?
- Where do you keep the money you save?
- How do you use the money that you have saved?

Example

- Let's look at these two examples:

Example 1:

Suhani works in a good company and earns Rs.30,000 month. She always saves 5000 per month and keeps it aside as a personal saving. She keeps the money at home and has saved quite a lot. One day her mother has a medical emergency and has to be taken to the hospital. Her family is worried about the amount they have to spend for the treatment. It will cost them atleast 40,000.

Suhani says tells her family not to worry and that she has about 50,000, which she has saved over the months.

Example 2:

Jasmeet works in the same company and earns the same as Suhani. She is very fond of shopping and spends most of her money on buying new clothes. At the end of the month, she is always asking her father for money as her pay is finished.

Ask

- Who do you identify with –Suhani or Jasmeet ?
- How do you think Suhani manages to save money which Jasmeet is unable to do?

Say

- We should always set aside some and save some money from our monthly pay. The future is unpredictable. Saving money not only gives you a sense of financial security but it can be used in case of emergencies.
- Discuss “Importance of Saving” with the participants as given in the Participant Handbook.

Ask

- What are the benefits of saving money?
- What does being financially independent mean to you?

Say

- Discuss “Benefits of Saving” with the participants as given in the Participant Handbook.
- Now let us continue with Suhani's story. Suhani has told her family not to worry and that she has about 50,000, which she has saved over the months. The family is happy about Suhani's decision of saving money, which will be of great help for them now.

Suhani is going to the hospital today to pay the first instalment for the treatment. Suddenly finds only 35,000 in her cash box when she counts and does not remember using it. She has not kept any record and now she is upset.

Ask

- Was it a good decision by Suhani to save a part of her earnings every month?
- Was it a wise decision to keep all her savings as cash in a cash box?
- Could she have managed to save money in a better and more effective manner?
- Do you want to learn how to save money and use it effectively?

Say

- Let's learn personal saving with the help of a group activity.

Team Activity

Personal Finance- Why to save

- This activity has two parts:

PART 1

WAYS TO SAVE MONEY

- You are earning 30,000/- per month. You have recently changed your job and have to move to a metropolitan city. You are now living as a paying guest paying 10,000/- per month. Your other estimated expenditures like travel, food, recreation would be around Rs. 17, 000 per month.
- Make a list of different ways to save money.

PART 2

HOW WILL YOU USE THE MONEY

- After a year how much have you been able to save?
- How will you use the money that you have saved?

Do

- Divide the class into groups of four.
- Instruct the participants to think and prepare a list of the various ways they can save money.
- Give the participants 10 minutes to prepare the list.
- Once done, instruct them to think of how they could use the money they have saved.
- Give the participants 10 minutes to prepare the list.
- Keep a check on time. Tell the group to wind up quickly if they go beyond the given time limit.

Activity De-brief

- What were the different ways you could save money?
- How much money were you able to save?
- How will you use the money you have saved in one year?

Say



- Discuss the importance of personal finance and why it is important to save money.

Summarize



You can summarize the session by discussing:

- The importance of saving money.
- Ways to save money.
- How the money saved can be used for different purposes.

UNIT 9.3.2: Types of Bank Accounts, Opening a Bank Account

Unit Objectives

At the end of this unit, participants will be able to:

- Discuss the main types of bank accounts
- Describe the process of opening a bank account

Resources to be Used

- Account opening sample forms
- Participant Handbook

Ask

- How many of you save money?
- Where do you keep the money you save?
- How many of you have a bank account?
- What type of account do you have?

Example

- Let's look at the given example:

Reena is in the third year of college but in the evening she gives tuitions for children living in her colony. She earns 15,000/- per month. As her students stay in different parts of the city, she has to walk a lot.

To save time, she decides to buy a second hand scooter for herself. But she has to save money for it. Her class mate advises her to open a recurring deposit account in the bank.

She goes to the bank close to her home. The personal manager gives her some forms to fill. She is confused as she has never done this before. Her elder sister has an account in the same bank. She asks for help from her sister. She goes to the bank the next day with her sister. The personal banker gives her a list of documents that she will need to submit with the form for opening an account. The banker advises her to open a 6 months recurring deposit.

Ask

- Do you try to save money monthly but have to spend it on unforeseen expenditure?
- Have you ever thought of depositing your savings in a bank?

Say

- Before opening a bank account, you need to know the types of accounts we have in India.
- Discuss “Types of Bank Accounts” with the participants as given in the Participant Handbook.

Ask

- Can someone say what are the different types of bank accounts?

Say 

- Let's learn about the different types of bank accounts through an activity.

Team Activity 

- Divide the class in four groups.
- Label the groups as savings account, current account, recurring account and fixed deposit.
- On a chart paper, ask them to write the key points of their account.

Activity De-brief

- Ask each group to present the key points of their account.

Say 

- Now that you know about the four different types of accounts, let's learn how to open a bank account.
- Discuss "Opening a Bank Account" with the participants as given in the Participant Handbook.
- Discuss "Tips" that the participants should keep in mind while opening a bank account as given in the Participant Handbook.

Ask 

- What are the main documents required for opening a bank account?
- What are some important points to ask the bank personnel while opening an account?

Say 

- Mention officially valid KYC documents (refer to the Participant Handbook)
- Now, let's understand the procedure of opening a bank account through an activity.

Team Activity **Opening a Bank Account**

- This activity is done in groups.
- Divide the class in groups of four or six.

PART 1**FILLING A BANK ACCOUNT OPENING FORM**

- You have to fill a bank opening form.
- You can refer to the section "Opening a Bank Account" of your Handbook for reference.
- List all the steps that you will be required to fill in the form.
- List the documents that you needs for filling the form.
- Now fill in the form.

Activity De-brief**How did you design the form?**

- What all details did you fill in the form?
- What were your KYC documents?
- How would this activity help you in future?

Do

- Instruct the participants to read the section "Opening a Bank Account" of the Participant Handbook.
- Give each group one sample account opening form.
- Give the participants 5 minutes to read the form.
- Give them 15 minutes to fill it.
- Assist them by explaining each category and how to fill it.
- Keep a check on time.
- Tell the group to wind up quickly if they go beyond the given time limit.

Summarize

Note:

- You can summarize the unit through a role play.
 - ♦ A person wanting to open an account in the bank.
 - ♦ What is the procedure that he will go through?
 - ♦ Discuss the key points of different types of bank accounts.
 - ♦ How to select the type of account
 - ♦ How to fill the account opening form.
- A sample account opening form is given in the following page for reference. Use it for the activity in the class.

Sample Bank Account Opening form.

Photograph	XXX Bank																																																												
SAVING BANK ACCOUNT OPENING FORM																																																													
Account No.: _____	Date: _____																																																												
<table border="1" style="width: 100%; border-collapse: collapse;"> <tr><td colspan="2">Name of the Branch</td></tr> <tr><td colspan="2">Village/Town</td></tr> <tr><td colspan="2">Sub District / Block Name</td></tr> <tr><td colspan="2">District</td></tr> <tr><td colspan="2">State</td></tr> <tr><td colspan="2">SSA Code / Ward No.</td></tr> <tr> <td>Village Code / Town Code</td> <td>Name of Village / Town</td> </tr> </table>		Name of the Branch		Village/Town		Sub District / Block Name		District		State		SSA Code / Ward No.		Village Code / Town Code	Name of Village / Town																																														
Name of the Branch																																																													
Village/Town																																																													
Sub District / Block Name																																																													
District																																																													
State																																																													
SSA Code / Ward No.																																																													
Village Code / Town Code	Name of Village / Town																																																												
Applicant Details:																																																													
<table border="1" style="width: 100%; border-collapse: collapse;"> <tr> <td style="width: 15%;">Full Name</td> <td style="width: 15%;">Mr./Mrs./Ms.</td> <td style="width: 30%;">First</td> <td style="width: 30%;">Middle</td> <td style="width: 10%;">Last Name</td> </tr> <tr><td colspan="5">Marital Status</td></tr> <tr><td colspan="5">Name of Spouse/Father</td></tr> <tr><td colspan="5">Name of Mother</td></tr> <tr><td colspan="5">Address</td></tr> <tr><td colspan="5">Pin Code</td></tr> <tr> <td colspan="3">Tel No. Mobile</td> <td colspan="2">Date of Birth</td> </tr> <tr> <td colspan="3">Aadhaar No.</td> <td colspan="2">Pan No.</td> </tr> <tr><td colspan="5">MNREGA Job Card No.</td></tr> <tr><td colspan="5">Occupation/Profession</td></tr> <tr><td colspan="5">Annual Income</td></tr> <tr><td colspan="5">No. of Dependents</td></tr> </table>		Full Name	Mr./Mrs./Ms.	First	Middle	Last Name	Marital Status					Name of Spouse/Father					Name of Mother					Address					Pin Code					Tel No. Mobile			Date of Birth		Aadhaar No.			Pan No.		MNREGA Job Card No.					Occupation/Profession					Annual Income					No. of Dependents				
Full Name	Mr./Mrs./Ms.	First	Middle	Last Name																																																									
Marital Status																																																													
Name of Spouse/Father																																																													
Name of Mother																																																													
Address																																																													
Pin Code																																																													
Tel No. Mobile			Date of Birth																																																										
Aadhaar No.			Pan No.																																																										
MNREGA Job Card No.																																																													
Occupation/Profession																																																													
Annual Income																																																													
No. of Dependents																																																													

Detail of Assets	Owning House : Y/N	Owning Farm :
	Y/N	
	No. of Animals :	Any other :
Existing Bank A/c. of family members / household	Y / N	If yes, No. of A/cs. _____
Kisan Credit Card	Whether Eligible Y / N	

I request you to issue me a **Rupay Card**.

I also understand that I am eligible for an Overdraft after satisfactory operation of my account after 6 months of opening my account for meeting my emergency/ family needs subject to the condition that only one member from the household will be eligible for overdraft facility. I shall abide by the terms and conditions stipulated by the Bank in this regard.

Declaration:

I hereby apply for opening of a Bank Account. I declare that the information provided by me in this application form is true and correct. The terms and conditions applicable have been read over and explained to me and have understood the same. I shall abide by all the terms and conditions as may be in force from time to time. I declare that I have not availed any Overdraft or Credit facility from any other bank.

Place:

Date:

Signature / LTI of Applicant

Nomination:

I want to nominate as under				
Name of Nominee	Relationship	Age	Date of Birth in case of minor	Person authorised in case to receive the amount of deposit on behalf of the nominee in the event of my /minor(s) death.

Place:

Date:

Signature / LTI of Applicant

Witness(es)*

1. _____

2. _____

*Witness is requires only for thumb impression and not for signature

UNIT 9.3.3: Costs: Fixed vs. Variables: What are Fixed and Variable Costs?

Unit Objectives

At the end of this unit, participants will be able to:

- Differentiate between fixed and variable costs

Resources to be Used

- Participant Handbook
- Blank sheets of paper
- Pens

Ask

- What is cost?
- Will a telephone bill fall under the category of a fixed or variable cost?

Say

- Discuss: Fixed and Variable cost with examples. Let us do a small activity.

Team Activity

Identify the type of cost

1. Rent
2. Telephone bill
3. Electricity bill
4. Machinery
5. Insurance
6. Office supplies/ Raw materials
7. Employee salaries
8. Commission percentage given to sales person for every unit sold
9. Credit card fees
10. Vendor bills

Do

- Divide the class into two groups. Read out the list of costs given in the activity.
- Read out each item from the cost list and ask the groups in turns to identify whether it is a fixed or variable cost.

Say

- We saw that your utility bills like rent, electricity, telephone etc. are all fixed costs because you have to pay it every month.
- Variable costs is an expense which varies with production output or volume. For example commission, raw material etc.
- Discuss “Cost: Fixed vs. variables” with the participants as given in the Participant Handbook.
- Illustrate the relation between the costs with a graph.

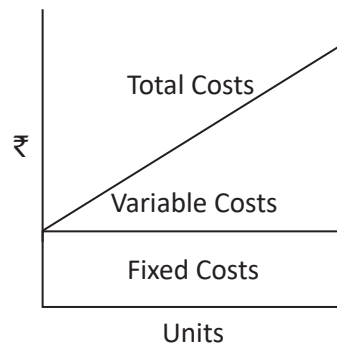

- Let's learn the difference between fixed and variable cost with the help of an activity.

Team Activity

Fixed vs. Variable Costs

- This is a group activity.

- You want to start your own entrepreneur business.
- State the type of business you want to start.
- List down all the cost or requirements for your business.
- How will you differentiate between the fixed and variable cost.

Activity De-brief

- What is the total cost of your business?
- What are the fixed costs?
- What are the variable costs?
- How did you differentiate between the fixed and variable costs?

Do

- Instruct the participants that this is group work.
- Divide the class into small groups of 4 or 6.
- Give each group a sheet of paper.
- Tell the participants that they have to start their own entrepreneur business.
- Ask them the type of business they want to start.
- Instruct them to differentiate between the fixed and the variable costs of the business they want to start.
- Give the participants 15 minutes to discuss and write.
- Keep a check on time. Tell the group to wind up quickly if they go beyond the given time limit.

Summarize

- Note: You can summarize the unit either by having a role play between a consultant and a budding entrepreneur explaining the differences between fixed and variable costs or by discussing the key points of the unit.

Notes for Facilitation

- Answers for the activity - Identify the type of cost

1. Rent	(Fixed)
2. Telephone bill	(Fixed)
3. Electricity bill	(Fixed)
4. Machinery	(Fixed)
5. Insurance	(Fixed)
6. Office supplies/ Raw materials	(Variable)
7. Employee salaries	(Fixed)
8. Commission percentage given to sales person for every unit sold	(Variable)
9. Credit card fees	(Variable)
10. Vendor bills	(Variable)

UNIT 9.3.4: Investments, Insurance and Taxes

Unit Objectives

At the end of this unit, participants will be able to:

- Describe the main types of investment options
- Describe the different types of insurance products
- Describe the different types of taxes

Resources to be Used

- Participant Handbook

Ask

- Ask the participants- “What do you see first thing in when you get your mobile bill? Apart from the amount and due date do you have a look at the taxes you are being billed for?”
- Why do you think people get their cars insured or have a medical insurance?
- You have saved money and want to invest it, how would you decide what is the best investment for your money?

Example

- Let's have a look at a few scenarios.

Ranbir has sold his house and deposited the money in his bank. His Chartered Accountant tells him that he will have to re-invest the money otherwise he will have to pay capital tax. What is capital tax and how is it different from income tax?

Jasmeet and Anup are blessed with a baby girl. They decide to have an insurance policy that will mature when their daughter is ready to higher education.

Shivani is working in a corporate office and getting good pay. She will have to pay income tax so she decides to invest her money in tax saving schemes. She goes to the bank manager to discuss the best products in which she can invest.

Say

- Discuss the Investment, Insurance and Taxes as given in the Participant Handbook.

Ask

- How do investments, insurances and taxes differ from each other?

Say

- Let's learn the differences between the three by having an activity.

Say

- We will have a quiz today.

Team Activity

- The activity is a quiz.

Do

- Divide the class into groups of three and give a name to each group
- Explain the rules of the quiz. For each correct answer the group gets 1 mark. If the group is unable to answer the question is rolled over to the next group.
- Explain the purpose and duration of the activity.
- On the blackboard write the names of the groups.
- Ask the questions of the quiz.
- Keep a score for the groups.
- Set guidelines pertaining to discipline and expected tasks.

Summarize

- Summarize the unit by discussing the key points and answering question

Notes for Facilitation

Questions for the quiz

1. What are bonds?
Bonds are instruments used by public and private companies to raise large sums of money.
2. Who issues the bonds?
Private and public companies issue the bonds.
3. Why are bonds issued?
To raise large amount of money as it cannot be borrowed from the bank.
4. Who is the buyer of stocks and equities?
The general public is the buyer.
5. What types of scheme is the Sukanya Samriddhi Scheme?
Small Saving Scheme
6. What is the difference between mutual and hedge funds?
Mutual funds are professionally managed financial instruments that invest the money in different securities on behalf of investors. Hedge funds invest in both financial derivatives and/or publicly traded securities.
7. Why is a loan taken from the bank to purchase real estate?
To lease or sell to make profit on appreciated property price.
8. Name the two types of insurances?
Life Insurance and Non-life or general insurance
9. Which insurance product offers financial protection for 15-20 years?
Term Insurance
10. What is the benefit of taking an endowment policy?
It offers the dual benefit of investment and insurance.
11. Mr. Das gets monthly return on one of his insurance policies. Name the policy?
Money Back Life Insurance

12. What are the two benefits of a Whole Life Insurance?

It offers the dual benefit of investment and insurance

13. Which policy covers loss or damage of goods during transit?

Marine Insurance

14. After what duration is the income tax levied?

One financial year

15. What is long term capital gain tax?

It is the tax payable for investments held for more than 36 months.

16. Name the tax that is added while buying shares?

Securities Transaction Tax

17. What is the source of corporate tax?

The revenue earned by a company.

18. Name the tax whose amount is decided by the state?

VAT or Value Added Tax

19. You have bought a T.V. What tax will you pay?

Sales Tax

20. What is the difference between custom duty and OCTROI?

Custom duty is the charges payable when importing or purchasing goods from another country. OCTROI is levied on goods that cross borders within India.

UNIT 9.3.5: Online Banking, NEFT, RTGS, etc.

Unit Objectives

At the end of this unit, participants will be able to:

- Discuss the uses of online banking
- Discuss the main types of electronic funds transfer

Resources to be Used

- Participant Handbook
- Computer System with internet connection
- Debit card

Ask

- When was the last time you visited a bank?
- How do you pay your bill for electricity and telephone?
- Have you ever tried to transfer money from one bank account to another bank account using the online banking facility?

Say

- Most of us lead a busy life. Time has become more important than money. In this busy schedule no one has time to stand in bank queues. That's where Online Banking comes in. Online banking or internet banking means accessing your bank account and carrying out financial transactions through the internet.
- Discuss "What is online banking?" from the Participant Handbook.
- There are various advantages of online banking:
 - ♦ It saves time, as you need to visit the branch. .
 - ♦ You can conduct your banking transactions safely and securely without leaving the comfort of your home.
 - ♦ Online Banking also gives you round the clock access.
 - ♦ Online Banking makes it possible for you to pay your bills electronically.

Do

- Show them how they can use the internet banking.
- Use the computer system and show the demo videos on how to use internet banking provided on most banking sites. the computer system.
- Tell the class the various features of online banking:
 - ♦ Through their website set-up your online account.
 - ♦ Choose a secure username and password.
 - ♦ Set-up your contact information.
 - ♦ Once your information is verified, you are good to go.
 - ♦ Once you enter the portal explore all the features and learn your way through the portal.
- Discuss about maintaining the security of the online account.

Say 

- One of the biggest advantage that online banking offers, as discussed earlier, is transferring money from one account to another. This transaction is called electronic funds transfer. Electronic transfers are processed immediately with the transferred amount being deducted from one account and credited to the other in real time, thus saving time and effort involved in physically transferring a sum of money.
- Discuss “Electronic Funds Transfer” from the Participant Handbook.

Do 

- Discuss how to transfer money from one account to another using online banking (NEFT/ RTGS, etc.).
- Illustrate with an example.

Summarize 

- Close the discussion by summarizing the about online banking.
- Ask the participants if they have any questions related to what they have talked about so far.

UNIT 9.4: Preparing for Employment & Self Employment

Key Learning Outcomes

At the end of this unit, participants will be able to:

1. Discuss the steps to follow to prepare for an interview
2. Discuss the steps to create an effective Resume
3. Discuss the most frequently asked interview questions
4. Discuss how to answer the most frequently asked interview questions
5. Identify basic workplace terminology

UNIT 9.4.1: Interview Preparation: How to Prepare for an Interview?

Unit Objectives

At the end of this unit, participants will be able to:

- Discuss the steps to follow to prepare for an interview

Resources to be Used

- Participant Handbook

Ask

- Have you ever attended an interview?
- How did you prepare before going for an interview?

Say

- An interview is a conversation between two or more people (the interviewer(s) and interviewee) where questions are asked by the interviewer to obtain information from the interviewee.
- It provides the employer with an opportunity to gather sufficient information about a candidate and help them select the ideal candidate.
- It also provides the interviewee with an opportunity to present their true potential to the employer, build confidence and help make a decision about the job by asking questions regarding designation, salary, perks, benefits, promotions, transfers, etc.
- Let's do an activity to understand how to prepare for interviews better.

Activity 1

- Introducing Yourself

Do

- Select a participant and ask him/her to answer the following questions: "What can you tell me about yourself?"
- Give the participant at least one minute to speak.
- Once he/she is done, ask the rest of the participant what they gathered about the participant who was providing information.
- Now repeat the exercise with five other participants.

Ask

- What information you should include when you are describing or introducing yourself in an interview?
- What information you should not include when you are describing or introducing yourself in an interview?

Say

- Tell the participants that when an interviewer asks you to say something about yourself, he/she is not asking you to present your life history.
- Introduction should be short and crisp, and should present you in a positive light. It should include the following points:
 - ♦ Any work experience that you might have
 - ♦ A brief summary of your educational qualifications
 - ♦ Your strengths and achievements
 - ♦ Any special projects that you might have been part of
- The following topics should be avoided during an introduction:
 - ♦ Detailed description of your family (unless you are specifically asked to do so)
 - ♦ Too much information about your weaknesses
 - ♦ Information that is not true

Do

- Congratulate each participant for sharing their points.
- Ask the audience to applaud for them.
- Ask de-brief questions to cull out the information from each group.
- Keep a check on time.

Activity 2

- Planning the right attire

Do

- Describe 2 individuals to the participants. One is wearing a casual t-shirt, jeans, and slippers. He has not combed his hair and neither has he trimmed or shaved his beard. The other individual is dressed formally with a shirt and pant, and is well-groomed. He has also worn formal shoes and a belt. Ask the participants which person would they prefer to hire in their organization and why?

Summarize

- Close the discussion by discussing 'how to prepare for an interview' as discussed in the Participant Handbook.
- You can add the following points to it:
 - ♦ Tell the participants to create a positive and good impression in an interview. It is important for them to prepare for an interview beforehand.
 - ♦ The interviewer analyses not only your technical knowledge in relation to the job, but also whether or not you are a fit for the organization.
 - ♦ Every employer looks at the whole package and not just one or two things in isolation. Therefore, the way you dress and the way you present yourself is also important along with your skills and talents.
 - ♦ The participants will get only one chance to create a good first impression.

UNIT 9.4.2: Preparing an Effective Resume: How to Create an Effective Resume?

Unit Objectives

At the end of this unit, participants will be able to:

- Discuss the steps to create an effective Resume

Resources to be Used

- Participant Handbook
- Blank papers
- Pens

Ask

- When preparing for an interview, what are the most important things that you need to do?
- What documents do you carry with you, when you go for an interview?
- What is a resume?
- Why do you need a resume?

Say

- Resume is not just a sheet of paper with your qualifications printed on it.
- It is a selling tool that will help the employer to see how and what you can contribute for company.
- Talk about the steps involved in creating an effective/attractive resumes discussed in the Participant Handbook.
- Now let's prepare a resume to understand the process in a better way.

Do

- This is an individual activity.
- Give the details of the activity.
- Instruct them to read the activity carefully.
- The participant is expected to make an attractive resume based on the information provided.
- Give the class 25-30 minutes to study the case and create a resume.
- At the end of 30 minutes, the participants should exchange the resume with the person sitting next to him or her.
- Every participant will evaluate the resume prepared with their fellow participants.

Say

- Do you think the candidate should apply for the job posting described in the advertisement?
- We have already discussed the steps involved in creating an effective/attractive resumes.
- Now let's prepare a resume for the candidate details given in the activity.

Activity

Case Study Analysis

- In the first section of the activity, you are being given the information about a candidate who is applying for a particular job.
- In the second section, you are being given the detailed description of the job posting. Create a resume for the candidate to apply for the job posting.
- Use the information that has been provided about the candidate to create this resume.

Candidate Details

Nipesh Singla was born on 20th April, 1988 in Chandigarh, India. He currently resides at 1XX7, Sector XX D, Chandigarh –160018. His mobile number is 988XXXXX01, and e-mail address is nxxxxxxxla@gmail.com. Nipesh attended middle and senior school at Government Boys Senior Secondary School, Sector 15, Chandigarh. He has been a very talented boy since school. He was fond of painting and watching old Hindi movies. As part of a school charity program, he volunteered at the children's hospital during his senior years.

In July 2007, he joined Westwood School of Hotel Management, Zirakpur to pursue a diploma course in Hotel Management and Catering. After completing this course, he joined XYZ Group of Hotels as a Housekeeping intern in June 2010 for six months. In this role, he was responsible for cleanliness and maintenance of one floor in the hotel. Taking advantage of his strong interpersonal skills, he also got opportunities to make housekeeping arrangements for corporate meetings. While pursuing education, he gained working knowledge of Microsoft Word, Excel, Access and PowerPoint.

Nipesh is detail-oriented, flexible and adaptable. He has successfully worked with a diverse work force. He gelled well with his peers, both in college and during his internship. After completing the internship, his objective has been to find a job opportunity where he can use his skills and experience. Backed by experience, he is confident about his skills as housekeeping assistant.

Job Posting

* Do you see yourself as a HOUSEKEEPING SUPERVISOR?

What's your passion? Whether you're into cricket, reading or hiking, at IHG we are interested in YOU. At IHG, we employ people who apply the same amount of care and passion to their jobs as they do in their hobbies - people who put our guests at the heart of everything they do. And we're looking for more people like this to join our friendly and professional team.

THE LOCATION:

At the moment, we are looking for HOUSEKEEPING SUPERVISOR to join our youthful and dynamic team at Holiday Inn Amritsar, Ranjit Avenue in Amritsar, Punjab (India). Holiday Inn Amritsar is ideally located in Amritsar's commercial district on Ranjit Avenue with the world famous Golden Temple located only a short distance away. Sparkling chandeliers mark an incomparable arrival experience as you escape to the welcoming environment that is, Holiday Inn Amritsar. The fresh international brand to celebrate and explore Amritsar.

Salary: Negotiable

Industry: Travel / Hotels / Restaurants / Airlines / Railways

Functional Area: Hotels, Restaurants

Role Category: Housekeeping

Role: Housekeeping Executive/Assistant.

Desired Candidate Profile

Friendly, pleasant personality, Service - oriented.

You should ideally be Graduate/ Diploma holder in HM and at least 2 years of experience as a supervisor in good brand with good communication skills, English is a must.

In return we'll give you a competitive financial and benefits package. Hotel discounts worldwide are available as well as access to wide variety of discount schemes and the chance to work with a great team of people. Most importantly, we'll give you the room to be yourself.

*Please get in touch and tell us how you could bring your individual skills to IHG.

Education-

UG: Any Graduate/ Diploma holder

PG: Post Graduation Not Required

Say

- Now, let's share the resume with the fellow participant sitting next to you and evaluate each other's effort.

Do

- Congratulate each participant for making their first attempt towards creating an effective resume.
- As a follow up activity, you can suggest them to prepare their own resume and show it to you the next day.

Summarize

- Close the discussion by showing some effective resume samples to the candidates.
- Ask the participants what they have learnt from this activity.
- Ask if they have any questions related to what they have talked about so far.

Notes for Facilitation

- Keep printed copies of the activity ready for the session.
- Put down the suggested format of the resume on the board while explaining the steps in preparing a resume.
- Do check the participants' resume and suggest necessary changes.
- Suggested example for the case presented:

Nipesh Singla

#1XX7, Sector XX-D

Chandigarh-160018

Mobile No: 91-988XXXXX01

E-mail: nxxxxxxxxla@gmail.com

Objective: Seeking an opportunity to use my interpersonal skills and experience to contribute to your company's growth, profitability and objectives.

Professional strengths:

- Proficient in housekeeping
- Experienced in and capable of working with a diverse work force
- Team player and friendly in nature
- Successful working in a multi-cultural environment

- Detail oriented, flexible, and adaptable
- Knowledge of Microsoft Word, Excel, Access and PowerPoint

Educational background:

- Diploma in Hotel Management and Catering, Westwood School of Hotel Management, Zirakpur
- High School, Government Boys Senior Secondary School, Sector 15, Chandigarh

Professional internships:

- Housekeeping Intern, XYZ Group of Hotels, New Delhi (June 2010 – August 2010)
 - ♦ Responsible for cleanliness and maintenance of one floor in the hotel.
 - ♦ Got opportunities to make housekeeping arrangements for corporate meetings.

Volunteer Work:

- Student volunteer at children's hospital in Chandigarh.

Nipesh Singla

UNIT 9.4.3: Interview FAQs

Unit Objectives

At the end of this unit, participants will be able to:

- Discuss the most frequently asked interview questions
- Discuss how to answer the most frequently asked interview questions

Resources to be Used

- Participant Handbook

Say

- Tell the participants you will provide them with interview situation and questions and they have to try to answer them.
- Tell them you will also explain the different ways to approach these questions.

Do

- Divide the class in pairs and ask the participants to perform a role play.
- One partner will play the role of the interviewer while the other will play the role of the interviewee.
- Tell them the interviewer can start the interview by asking the interviewee to introduce himself/herself.
- Call all the pairs one by one in front of the class to enact the role play.
- Follow the same pattern for all other situations.
- Time allotted for each situation is 8-10 minutes.
- Congratulate each participant for giving their input.
- Ask the class to applaud each time a team has completed their role play.
- Keep a check on time.

Role Play

Conduct a role play for the situation given.

Situation 1

- The interviewer will start by asking the interviewee a few generic questions such as:
 - ♦ What is your name?
 - ♦ Tell me something about yourself?
 - ♦ Can you tell me something about your family?
- Then, the interviewer will bluntly ask the following questions:
 - ♦ How do you explain this huge time gap in your resume?
 - ♦ What is the reason for this?
 - ♦ Weren't you looking for a job or is it that no one selected you?

Say

De-brief:

- When you put information on your resume, you should be prepared to answer any questions about it.
- Be present and focused on the questions being asked to you.
- One way of tackling the blunt questions is to tell the interviewer you did not come across an opportunity where you were sufficiently satisfied with both the remuneration offered as well as the profile. Therefore, you waited for the right opportunity to come along while looking for an ideal job.

Role Play

Conduct a role play for the situation given.

Role Play – Situation 2

- The interviewer will start by asking the interviewee a few generic questions such as:
 - ♦ What is your name?
 - ♦ Tell me something about yourself?
 - ♦ Can you tell me something about your family?
- Then, at the end of the interview, ask the interviewee:
 - ♦ There are over 200 people who have applied for this job, some with excellent work experience. Why should I hire you?

Say

De-brief:

- There is nothing wrong with stating your strengths and achievements. However, do not come across as arrogant or too boastful.
- You need show the interviewee that you have unique skills or talents to contribute to the company. The interviewer needs to know how you stand apart from the rest of the crowd.
- Tell the interviewer you are looking forward to working with the company and that you are a hard-working individual.

Role Play

Conduct a role play for the situation given.

Role Play – Situation 3

- The interviewer will start by asking the interviewee a few generic questions such as:
 - ♦ What is your name?
 - ♦ Tell me something about yourself?
 - ♦ Can you tell me something about your family?
- Then, lean forward, clasp your hands on the table and in a soft voice ask the interviewee:
 - ♦ Did you ever experience any neglect or disregard from your previous office? In other words, did you ever suffer because your office or team displayed favouritism?

Say

De-brief:

- Keep this in mind: Do not criticize anyone during an interview.
- You are free to express your opinion, however, your language, answers, body language, and the tone of your voice should remain constructive and neutral.
- Since criticism will show you in negative light, you should keep your answers honest yet diplomatic.
- You can tackle such questions by saying, “I got along well with most of my faculty and peers.”

Role Play

Conduct a role play for the situation given.

Role Play – Situation 4

- The interviewer will start by asking the interviewee a few generic questions such as:
 - ♦ What is your name?
 - ♦ Tell me something about yourself?
 - ♦ Can you tell me something about your family?
- Then very bluntly ask the interviewee:
 - ♦ How long do you plan to stay with this company if you are selected?
- After the candidate responds, ask sarcastically:
 - ♦ Do you seriously mean that?

Say

De-brief:

- Don't provide unreal and idealistic answers.
- Your answers should be honest yet diplomatic. In a situation like this, the interviewer does not expect you to provide a specific timeline.
- You can say something like, “I would like to stay with the company as long as I can contribute constructively and develop as an employee, within the organization, professionally and financially.”

Role Play

Conduct a role play for the situation given.

Role Play – Situation 5

- The interviewer will start by asking the interviewee a few generic questions such as:
 - ♦ What is your name?
 - ♦ Tell me something about yourself?
 - ♦ Can you tell me something about your family?
- Ask him/her how important he/she thinks it is to be punctual in the corporate world.
- After he/she answers, look up sternly at the interviewee and in a crisp voice, say:
 - ♦ You were late for this interview by 10 minutes. That surely does not seem to be in line with what you just said?

Say

De-brief:

- Politely apologize for being late.
- You can add something such as, “I assure you this is not a habit”. All your future actions should be in line with this statement.
- Avoid giving any excuses.
- You might feel obligated to provide a justification for your tardiness, but the interviewer is not interested in that.
- Do not over apologize. Once this response is out of the way, turn your focus back to the interview.

Role Play

Conduct a role play for the situation given.

Role Play – Situation 6

- The interviewer will start by asking the interviewee a few generic questions such as:
 - ♦ What is your name?
 - ♦ Tell me something about yourself?
 - ♦ Can you tell me something about your family?
- After asking a few academic or job-related questions, ask the interviewee:
 - ♦ If you get this job, what salary package do you expect us to give you?

Say

De-brief:

- If there is no way for you to avoid this question, respond to the interviewer by providing a reasonable and well-thought out salary range.

Role Play

Conduct a role play for the situation given.

Role Play – Situation 7

- The interviewer will start by asking the interviewee a few generic questions such as:
 - ♦ What is your name?
 - ♦ Tell me something about yourself?
 - ♦ Can you tell me something about your family?
- Then, bringing the interview to a close, ask the interviewee:
 - ♦ Do you have any questions for me?

Say

De-brief:

- Ask relevant questions.
- Don't bombard the interviewer with questions.
- If you have questions about the result of the interview, you can limit your questions to 1 or 2. Keep them short and relevant like:
 - ♦ When will I be informed about the results of the interview?
 - ♦ What are the working hours?
 - ♦ Will the job require me to travel?

Explain

- Tell the participants to be prepared for answering different types of questions in an interview.
- Stay calm and focused, and take a moment to think about how you should respond. Always maintain a confident tone.
- Even if you don't intend to, your body language conveys your level of discomfort with a particular question. Try to keep your actions, tone, and gestures neutral.
- Maintain your composure while answering personal question.

Do

- Tell all the participants to form pairs again.
- Tell them to use the following list of frequently asked interview questions to conduct mock interviews.
- They will use all or some of these questions to conduct mock interviews with their partners.
- One partner will play the role of the interviewer while the other will play the role of the interviewee.
- After they are through asking and answering the questions, the roles will be reversed.
- The same list of questions will be used again.
- After each mock interview ask the interviewer to provide feedback and clear any doubts that may arise.
- Time allotted for each situation is 30-35 minutes.

Activity

Mock Interview Questions

Mock Interview Questions
Tell me something about your family.
What qualities would you look for in a Manager or a Supervisor?
Why did you apply for this job?
What do you know about this company?
How do you deal with criticism?
How do you plan to strike a good work-life balance?
Where do you see yourself five years from now?
Have you applied for jobs in other companies?
What kind of salary do you expect from this job?
Do you have any questions for me?

Summarize

- Close the discussion by discussing the questions in the both activities.
- Ask the participants what they have learned from this activity.
- Ask if they have any questions related to what they have talked about so far.

UNIT 9.4.4: Work Readiness – Terms and Terminology

Unit Objectives

At the end of this unit, participants will be able to:

- Identify basic workplace terminology

Resources to be Used

- Participant Handbook
- Chart papers
- Blank sheets of paper
- Pens

Ask

- What do you understand by workplace terminology?
- Are offer letter and contract of employment the same?

Say

- Let's start this unit with an activity.

Team Activity

Workplace terminology

- This is a group activity conducted in three parts.

Part 1

Sheila received a call from the recruiter of MND Company. Before she is recruited by the company, think of the recruitment process she will have to go through. Start from the telephone call to signing her letter of acceptance. Write down all the words that come to your mind.

Activity De-brief

- Have the participants read out the words they have written
- Encourage all the participants to participate in the activity

Do

- Divide the class into small groups of 4 or 6.
- Instruct the participants that they will be doing a brainstorming activity.
- Give them one chart paper each. Tell them to divide the chart in two parts.
- Instruct them that they have to use one half of the chart paper now. The other half will be used later.
- The participants have to write all the words that come to their mind related to the recruitment process.
- Give them 10 minutes to do the activity.
- Tell them that there are no right or wrong answers.
- Keep a track of the time.

Say 

- You all know quite a few words related to the terms used in the office.
- Let us talk about some new terms that have been missed out.
- Discuss “Work Readiness – Terms and Terminology” with the participants as given in the Participant Handbook.

Ask 

- Why is it important to know the workplace terms?
- How do they help?
- Can the words be categorised further?

Say 

- Let's now continue the activity.

Team Activity **Terms and Terminology**

- This is again a group activity. The members of the group remain the same as in Activity 1.

Part 2

With the help of the new terms you have learned, make a flow chart of the hiring process of MND Company.

Activity De-brief

- Ask the groups to share the flow charts and the new terms they added while preparing the flow chart.

Do 

- Instruct the participants that they have to use the 2nd half of the same chart they had used before.
- Using the new terminology and the terms they had previously written on the chart, they have to make a flow chart of the hiring process of the MND Company.
- Give them 10 minutes for this activity.
- Keep a check on time. Tell the group to wind up quickly if they go beyond the given time limit.

Say 

- Let's go ahead with the activity.

Team Activity **Terms and Terminology**

- The activity continues with the same group members.

Part 3

Sheila now works for the MND Company. She is not aware of the company culture and policies. She goes to the HR Department to get her doubts clarified. Can you think of the terms for which she wants clarity? Make a list of those words.

Activity De-brief

- Ask the groups to share their list of words. Some of the words are benefits, comp. time, deduction, employee training, holidays, lay-off, leave, maternity leave, mentor, notice, paternity leave, and time sheet.

Do 

- Instruct the participants to identify the key terms an employee of a company should know. They can use the same chart paper for this activity.
- Give them 5 minutes for this activity.
- Keep a check on time. Tell the group to wind up quickly if they go beyond the given time limit.

Summarize 

- Note: You can either summarize the key points of the unit or have a role play where an employee has just joined a company and the HR Manager explains the terms of employment.

UNIT 9.5: Understanding Entrepreneurship

Key Learning Outcomes



At the end of this unit, participants will be able to:

1. Discuss the concept of entrepreneurship
2. Discuss the importance of entrepreneurship
3. Describe the characteristics of an entrepreneur
4. Describe the different types of enterprises
5. List the qualities of an effective leader
6. Discuss the benefits of effective leadership
7. List the traits of an effective team
8. Discuss the importance of listening effectively
9. Discuss how to listen effectively
10. Discuss the importance of speaking effectively
11. Discuss how to speak effectively
12. Discuss how to solve problems
13. List important problem solving traits
14. Discuss ways to assess problem solving skills
15. Discuss the importance of negotiation
16. Discuss how to negotiate
17. Discuss how to identify new business opportunities
18. Discuss how to identify business opportunities within your business
19. Explain the meaning of entrepreneur
20. Describe the different types of entrepreneurs
21. List the characteristics of entrepreneurs
22. Recall entrepreneur success stories
23. Discuss the entrepreneurial process
24. Describe the entrepreneurship ecosystem
25. Discuss the purpose of the Make in India campaign
26. Discuss key schemes to promote entrepreneurs
27. Discuss the relationship between entrepreneurship and risk appetite
28. Discuss the relationship between entrepreneurship and resilience
29. Describe the characteristics of a resilient entrepreneur
30. Discuss how to deal with failure

UNIT 9.5.1: Concept Introduction (Characteristic of an Entrepreneur, types of firms/ types of enterprises)

Unit Objectives

At the end of this unit, participants will be able to:

- Discuss the concept of entrepreneurship
- Discuss the importance of entrepreneurship
- Discuss the characteristics of an entrepreneur
- Describe the different types of enterprises

Resources to be Used

- Participant Handbook

Say

- Let's start this session with some interesting questions about Indian entrepreneurs.

Team Activity

Quiz Questions

1. Who is the founder of Reliance Industries?
Dhirubhai Ambani
2. Who is the Chairman of Wipro Limited?
Azim Premji
3. Who launched e-commerce website Flipkart?
Sachin Bansal and Binny Bansal
4. Who is the founder of Paytm?
Vijay Shekhar Sharma
5. Who is CEO of OLA Cabs?
Bhavish Aggarwal
6. Who is the founder of Jugnoo?
Samar Singla (autorickshaw aggregator)
7. Who is the founder of OYO Rooms?
Bhavish Aggarwal

Do

- Tell them that you will ask them few questions about a few entrepreneurs.
- Divide the class in to two groups.
- In turns ask the quiz questions to the groups.
- If the answer is incorrect pass the question to the other group.
- Share the answer if the groups are not able to answer.
- Congratulate the participants who answered correctly.

Ask

- What do you understand by entrepreneurs?
- What is the importance of entrepreneurship in today's scenario?
- What do you think are the characteristics of successful entrepreneurs?
- What are different types of enterprises that an entrepreneur in India can own and run?

Say

- Talk about entrepreneurs, importance of entrepreneurship, characteristics of successful entrepreneurs, and different types of enterprises in India as discussed in the Participant Handbook.
- Tell the participants, stories of successful Indian entrepreneurs- their struggles, the moments of heartbreak, the perseverance and triumph.
- Ask them if they know of any such entrepreneur.

Summarize

- Close the discussion by summarizing about the opportunities for entrepreneurs in India.

Notes for Facilitation

- Check out different Government schemes for small entrepreneurs. Share the information with the participants.
- You can tell them about the government websites like Start Up India, mudra.org.in etc.
- Discuss about various schemes and policies by the Government of India for entrepreneurs.

UNIT 9.5.2: Leadership and Teamwork

Unit Objectives

At the end of this unit, participants will be able to:

- List the qualities of an effective leader
- Discuss the benefits of effective leadership
- List the traits of an effective team

Resources to be Used

- Participant Handbook
- Blank sheets of paper
- Pens

Do

- Show the picture given below to the class.
- Ask them to quickly write on a piece of paper what comes to their mind after seeing the picture.
- Now ask them, “What do you understand from this picture?”
- Encourage participants to share their thoughts.

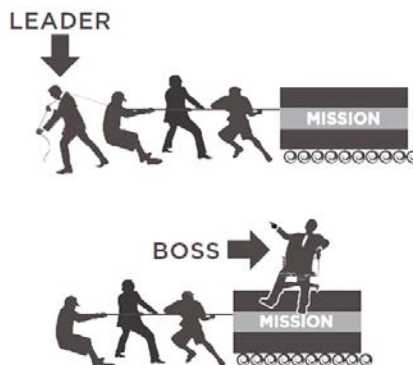

Say

- This picture depicts the qualities of a leader and the difference between a leader and a boss.
- A boss focuses on structure and inspires fear whereas a leader follows vision and generates enthusiasm.
- A boss blames employees for the breakdown whereas a leader fixes breakdowns.
- A boss depends on authority whereas a leader depends on goodwill.
- A boss says “I” and a leader says “We.”
- A boss drives employees whereas a leader coaches them.
- A boss takes credit whereas a leader gives credit.

Say

- Talk about leadership and leadership qualities for an entrepreneur as discussed in the Participant Handbook.

Ask

- Why is it important for a leader to be effective? How does it help the organization?

Say 

- Let us discuss benefits of effective leadership as discussed in the Participant Handbook.
- “Out-of-the-box thinking” is one of the new leadership styles. It means thinking differently and from a new perspective.

Ask 

- Do you consider yourself a team player?

Team Activity **Long Chain**

- This is a group activity.

Do 

- Divide the class into 2 teams.
- Ask each team to create a chain using materials they have in class such as shoe laces, belts, paper, handkerchief, ribbons, etc.
- The team that creates the longest chain wins the game.
- Observe if the participants are interacting with their team or working in isolation.
- Share your observations with the class.

Say **De-brief:**

- What did the winning team do differently?
- Who was responsible for the winning team's success?
- How does this activity explain the role of teamwork in entrepreneurial success?

Say 

- Tell the class that both the teams performed well.
- Discuss that the objective of this activity was to open communication channels and how this has been achieved.
- The participants should aim to keep the communication channels open when interacting with their peers and team members.
- It will set the pace and enthusiasm required for all the ensuing teamwork activities.
- Talk about teamwork and importance of teamwork in entrepreneurial success as discussed in the Participant Handbook.

Summarize 

- Close the discussion by summarizing about the importance of teamwork for employees.
 - ♦ Teamwork helps in reducing stress for the employees.
 - ♦ Teamwork helps employers in generating more number of solutions to a problem and developing improved communication amongst employees.
- Ask the participants what they have learned from these exercises.
- Ask if they have any questions related to what they have talked about so far.

UNIT 9.5.3: Communication Skills: Listening & Speaking: The Importance of Listening Effectively

Unit Objectives

At the end of this unit, participants will be able to:

- Discuss the importance of listening effectively
- Discuss how to listen effectively
- Discuss the importance of speaking effectively
- Discuss how to speak effectively

Resources to be Used

- Participant Handbook

Activity 1

Activity – Chinese Whisper

Step 1: Form a circle.

Step 2: Start a whisper chain. Any one participant will whisper a message into his/her neighbour's ear. No one else must hear the message. The message can be serious or downright silly.

Step 3: The next person who first heard the message should whisper the message very quickly to the person sitting next to them.

Step 4: The game goes on until the last person says whatever they heard out loud and the first person reveals the real message.

Compare them and have a great laugh!

Ask

De-brief questions:

- Was the original message the same as the message that is communicated at the end of the game?
- Why do you think there was a difference in the messages?

Say

- No, the original message was not same at the end of game.
- The barriers to communication like language, disturbance and noise, poor listening skills, boredom, poor speaking skills, etc. are the potential reasons this happens.
- There are various aspects to communication. Speaking skills and listening skills are two major components to any communication. There is always some room for improvement in the way we communicate.
- It is important to accept the reality of miscommunication and work to minimise its negative impacts.

Say 

- Communication is a two-way process where people exchange information or express their thoughts and feelings
- It involves effective speaking and effective listening.
- If I go to the store to get bread, I exchange money for the bread. I give something and get something in return. Communication takes place in the same manner. You have to provide and receive information for communication to take place.

Ask 

- How often do you hear these statements?
 - “You're not listening to me!”
 - “Why don't you let me finish what I'm saying?”
 - “You just don't understand!”
- What do you think the other person is trying to convey to you through these sentences?
- We will not talk about the importance of listening effectively as discussed in the Participant Handbook.

Say 

- Let's play a game to understand effective listening process better.

Do 

- This is a class activity.
- The participants need to answer the questions they hear.
- Instruct them to listen carefully.
- You will read it at a stretch and if need be repeat it once more.
- Tell the participants to raise their hand if they know the answer to the question asked.
- Keep a check on time.

Activity 2 

Riddles:

Is there any law against a man marrying his widow's sister?
If you went to bed at eight o'clock at night and set the clock's alarm to ring at nine o'clock, how many hours of sleep would you get?
Do they have a 26th of January in England?
If you had only one match and entered a dark room that had a kerosene lamp, oil heater, and a wood stove, what would you light first?
The Delhi Daredevils and the Chennai Super Kings play five IPL matches. Each wins three matches. No match was a tie or dispute. How is this possible?
There was an airplane crash. Every single person died, but two people survived. How is this possible?
If an airplane crashes on the border of two countries, would unidentified survivors be buried in the country they were travelling to or the country they were travelling from?
A man builds an ordinary house with four sides except that each side has a southern exposure. A bear comes to the door and rings the doorbell. What is the colour of the bear?

Answers:

There's no law against a man marrying his widow's sister, but it would be the neatest trick in the book since to have a widow, the man would have to be dead.

You'd get one hour's sleep since alarm clocks do not know the difference between morning and night.

Oh, yes. They have a 26th of January in England. They also have a 27th, a 28th, and so on.

First of all, you would light the match.

Who said the Delhi Daredevils and the Chennai Super Kings were playing against each other in those games?

Every SINGLE person died, but those two were married.

You can't bury survivors under any law especially if they still have enough strength to object.

The bear that rang the doorbell would have to be a white bear. The only place you could build a house with four southern exposures is at the North Pole where every direction is in South.

Ask**De-brief question:**

- What were the barriers that came into your way of listening?
- How can you overcome barriers to listening?

Say

- There is a difference between hearing and listening.
- If you don't listen properly, the message may be misunderstood.
- Be open-minded while listening to someone.
- It is important to listen effectively and carefully without making assumptions.

Activity 3**Elevator Pitch:**

You are in the lift of a hotel and you bumped into your former client who is a famous businessman. He has financed a lot of small business ventures and can finance your new start-up too. After exchanging pleasantries, he asks you what your new company does. You open your mouth, and then pause. Where do you even begin?

Then, as you try to organize your thoughts, his meeting is called, and he is on his way. If you would have been better prepared, you're sure that he would have stayed long enough to schedule a meeting with you too.

If you were given another chance, what would you have said to this person?

Do

- Start off the task by providing a beginning sentence to get the story started, and then go around the classroom getting each one to add a new sentence to keep the story going.
- This task should be done spontaneously allowing only a little time to think (30 seconds).
- For example: **There was once a student who was looking for a job after graduation.**

Notes for Facilitation



- Tell the participants to follow these steps to create a great pitch, but bear in mind that you'll need to vary your approach depending on what your pitch is about.
 1. **Identify Your Goal:** Start by thinking about the objective of your pitch. For instance, do you want to tell the potential clients about your organization? Do you have a great new product idea that you want to pitch to an executive or do you want a simple and engaging speech to explain what you do for a living?
 2. **Explain What You Do:** Start your pitch by describing what your organization does. Focus on the problems that you solve and how you help people. Ask yourself this question as you start writing: what do you want your audience to remember most about you? Keep in mind that your pitch should excite you first. After all, if you don't get excited about what you're saying neither will your audience. People may not remember everything that you say, but they will likely remember your enthusiasm.
 3. **Communicate Your USP:** Your elevator pitch also needs to communicate your unique selling proposition or USP. Identify what makes you, your organization or your idea unique. You'll want to communicate your USP after you've talked about what you do.
 4. **Engage with a Question:** After you communicate your USP, you need to engage your audience. To do this, prepare open-ended questions (questions that can't be answered with a "yes" or "no" answer) to involve them in the conversation. Make sure that you're able to answer any questions that he or she may have.
 5. **Put it all Together:** When you've completed each section of your pitch, put it all together. Then, read it aloud and use a stopwatch to time how long it takes. It should be no longer than 20-30 seconds. Remember, the shorter it is, the better!

Example:

Here's how your pitch could come together:

"My company deals with cloth retail online business and we use various e-commerce platforms to sell our products. This means that you can do shopping with ease and spend time on other important tasks. Unlike other similar companies, we have a strong feedback mechanism to find out exactly what people need. This means that, on average, 95 percent of our clients are happy with our products. So, how can you help us in creating our own web portal?"

6. **Practice:** Like anything else, practice makes perfect. Remember, how you say it is just as important as what you say. If you don't practice, it's likely that you'll talk too fast, sound unnatural or forget important elements of your pitch. Set a goal to practice your pitch regularly. The more you practice, the more natural your pitch will become. Practice in front of a mirror or in front of colleagues until the pitch feels natural.

Summarize



- Close the discussion by summarizing how to speak effectively as discussed in the Participant Handbook.

UNIT 9.5.4: Problem Solving & Negotiation Skills

Unit Objectives

At the end of this unit, participants will be able to:

- Discuss how to solve problems
- List the important problem solving traits
- Discuss ways to assess problem solving skills
- Discuss the importance of negotiation
- Discuss how to negotiate

Resources to be Used

- Participant Handbook

Ask

- What is a 'problem'?
- What do you think are the problems you may face in the process of becoming a successful entrepreneur?

Say

- Discuss the definition of problem as given in the Participant Handbook.
- In a hurdle race the hurdles are the obstacles on the way to reach your goal.
- Similarly, obstacles are the hurdles you may face while reaching your goal i.e. to set-up your own business. Your goal will be to reach the finishing line after crossing these hurdles.

Ask

- What do you do when you face a problem?
- How do you resolve it? You can pick examples from the question asked previously 'the problems they are likely to face in the process of becoming a successful entrepreneur'.

Say

- Discuss how to solve problems as given in the Participant Handbook.

Team Activity

- This is a group activity.
 - The groups will solve the problem and come up with the best solution in each case.
1. Unable to arrange for some extra finance for setting up a beauty parlour. The loan sanctioned and disbursed is not enough. You have tried all your contacts, friends and relatives. But unable to manage the extra amount. Bank will not sanction more amount as you have used up the complete sanction limit.
 2. You have rented a space for your business and all arrangements are done. You will be operating from the office space rented in two days. Now the owner comes up to you and says he wants to sell the place and wants you to vacate in 15 days.
 3. You have just set up your business and need extra human resource. You have tried inviting a few also tied up with an agency for getting the right candidate. But you are unable to get the right candidate. If the candidate is good, you cannot offer the salary demanded. If the candidate agrees to the salary, he/she has other demands like working hours to be reduced, leaves etc. which may not work for your set up.

Do 

- Divide the class into three groups. Give one scenario to each group.
- Explain the purpose and duration of the activity.
- Ask the groups to build on the scenario and present their solution as a role play.

Say **De-brief questions:**

1. What was the problem?
2. Is there any other alternative solution?
3. Is this the best solution presented?

Ask 

- Try to think of some people around you who are able to solve problems very easily. Even you or your friends might be approaching them when there is a problem. What qualities do they have? What personality traits do such people possess?

Say 

- Discuss the important traits for problem- solving as given in the Participant Handbook.

Ask 

- In order to build a successful organization, you need to hire people who possess good problem solving skills. How would you assess the level of problem solving skills of potential candidates before hiring them?

Say 

- Discuss how to assess for problem- solving skills as given in the Participant Handbook.

Summarize 

- Ask the participants the things that they have learnt so far.
- Ask if they have any questions related to what they have talked about so far.
- Summarize the discussion on problem solving.

Activity 

- The activity is to organise an election event. Select three volunteers from the group. They have to give a speech on their election manifesto to the class. They have to negotiate with the fellow participants and convince them to vote for them. The best negotiator will win the election.

Do 

- Ask three participants to volunteer for the activity.
- Explain the purpose and duration of the activity.
- Set guidelines pertaining to discipline and expected tasks.

Ask 

- Out of the three contestants, whom would you support? Why? What did they say or do which convinced you to make your decision?
- Have you ever tried to negotiate in your personal or professional life?
- Ask the class to share some of their experiences where they have been able to strike a deal by negotiating.

Say 

- Discuss “What is Negotiation?” as given in the Participant Handbook.

Ask 

- Why is it important to negotiate? As an entrepreneur, where do you think that negotiation skills will be needed?

Say 

- Discuss the importance of negotiation while starting a business as given in the Participant Handbook.

Say 

- Discuss the important steps to negotiate as given in the Participant Handbook.

Role Play 

- Conduct a role play activity.
- Ask the participants to assemble together.
- Explain the purpose and duration of the activity.
- Set guidelines pertaining to discipline and expected tasks.

Do 

- Divide them into groups of four (4) (depending on the batch size).
- Give them the hand-outs for role play scenarios.
- Two groups to be given scenarios on problem solving.
- Other two groups to be given scenarios on negotiation.
- The groups will build on the scenarios and prepare for the role play.
- Give the groups atleast 5 mins to discuss and be ready with the role play.
- Invite each group one by one to come and present their role play.

Problem solving Scenario 1

Avinash has a Mobile Repair Store in Allahabad. His outlet is one of the most popular one in the vicinity and he has great rapport with his customers. He is always well-dressed, jovial and full of energy.

It's around 11 AM, when a customer barges in to the shop and starts shouting at Avinash for giving her back the instrument which is still not working. The screen of her mobile is also cracked from one side. Avinash remembered thoroughly checking the handset before handing it over to the customer. The customer threatens to sue the company and to go to Consumer Court for cheating her.

Problem solving Scenario 2

You are running a successful small scale business, Shreeji Aggarbattis,. Your staff members do door to door selling and organise marketing campaigns in local markets. Your brand has established it's name in last few years.

Recently, lot of customers have been coming to you and lodging complaints that your staff members indulge in malpractices. Few of them informed you that a staff member engaged them in a friendly conversation. In the meanwhile, the other gave them lesser packets of aggarbattis than they paid for.

Another set of customers lodged complaint about the misconduct and rude behaviour of a particular staff member.

You often hear from your customers that the orders don't get delivered on time or wrong products get delivered.

You have already been struggling with shortage of staff and such complaints are a serious concern as it is hampering your brand image. What strategies will you adopt to solve this problem?

Negotiation Scenario 1

You have interviewed a prospective new employee who could be a key member of your new entrepreneurial venture. The new person is demanding a salary that is 20% higher than you thought based on your business plan. Finances are tight, yet you believe this person could make a significant impact on future profits. If you paid the required salary for the new person, then you would have to restructure your entire business plan. You've been searching for an individual with this skill level for three months. to the candidate is waiting for your response. Now you have to call him in to make the final negotiations.

Negotiation Scenario 2

You are a young entrepreneur who has just registered his start up project and applied for a bank loan accordingly. You receive a letter saying that your loan application has been rejected as your start up idea did not appeal to the bank and they think that it is not a revenue generating model. You have taken an appointment to meet the manager and show your negotiation skills to get your loan approved.

Notes for Facilitation

**Facilitating Role Plays****Preparing for the activity**

1. Carefully review the details of the scenario and the character descriptions.
2. Become familiar with the key issues being addressed in the scenario.
3. Study the provided material so that you are ready to address issues related to the situations depicted in the role-plays.
4. Anticipate and know how to address issues participants might raise during the activity.

Conducting the activity

1. Introduce the activity. Emphasize that role-playing provides participants with an opportunity to apply their new knowledge, skills, and tools in situations that simulate actual interactions with customers.
2. Ask participants to form pairs. Direct the members of each group to choose who will play the roles. Remind the groups that each participant should be given the opportunity to play/practice the different roles.
3. Conduct a demonstration so that participants become familiar with the expectations related to the roles and support materials.
4. Give the pairs/ groups 10 to 15 minutes to conduct the role-play (depending on the duration of the session).
5. After all the groups have finished with the role-play, conduct a debriefing session on each role-play.
6. Ask the groups to take five minutes to talk about what happened during the role-play. The groups should discuss the questions given in the debriefing for each role-play. Encourage participants to provide constructive criticism during their discussions.

Summarize



- Wrap the unit up after summarizing the key points and answering questions.

UNIT 9.5.5: Business Opportunity Identification: Entrepreneurs and Opportunities

Unit Objectives

At the end of this unit, participants will be able to:

- Discuss how to identify new business opportunities
- Discuss how to identify business opportunities within their business

Resources to be Used

- Participant Handbook
- Blank sheets of paper
- Pens

Ask

- How does an entrepreneur identify an opportunity?
- What do you think are the common queries or concerns faced by entrepreneurs?
- How can you identify new business opportunity?

Say

- Let's talk about opportunity, common queries or concerns faced by entrepreneurs, idea as an opportunity, factors to consider when looking for opportunities, ways to identify new business, and opportunity analysis as discussed in Participant Handbook.
- Let's do an activity to understand ways to identify business opportunities within your business.

Do

- Tell the class that this is an individual activity.
- Tell the participants to create a matrix on their notebooks.
- There will be four boxes in your matrix.
- Strength, Weakness, Opportunity and Threats will be the four headings of the matrix. This is called the SWOT matrix.
- Read out the questions to them and tell the participants they need to answer the questions asked in each matrix.
- Tell them they can also use their own understanding of themselves to fill the SWOT matrix.

Activity

Do your SWOT analysis

Strength

What are your strengths?
What unique capabilities do you possess?
What do you do better than others?
What do others perceive as your strengths?

Weakness

What are your weaknesses?
What do your competitors do better than you?

Opportunity

What trends may positively impact you?
What opportunities are available to you?

Threat

Do you have solid financial support?
What trends may negatively impact you?

Do



- Congratulate everyone for the class activity.
- Ask the audience to applaud for themselves.
- Allot the participants sufficient time to complete this activity, but do keep a check on time.
- Ask de-brief questions to cull out information from the participants.

Ask



De-brief questions:

- What are your weaknesses according to your SWOT analysis?
- Do you think you can change your weakness into strength? How?
- Do you think you can work on your threats? How?

Summarize



- Close the discussion by summarizing ways to identify business opportunities within your business.
- Ask the participants what they have learned from this exercise.
- Ask if they have any questions related to what they have talked about so far.

UNIT 9.5.6: Entrepreneurship Support Eco-System

Unit Objectives

At the end of this unit, participants will be able to:

- Explain the meaning of entrepreneur
- Describe the different types of entrepreneurs
- List the characteristics of entrepreneurs
- Recall entrepreneur success stories
- Discuss the entrepreneurial process
- Describe the entrepreneurship ecosystem
- Discuss the purpose of the 'Make in India' campaign
- Discuss the key schemes to promote entrepreneurs

Resources to be Used

- Participant Handbook
- Chart papers
- Marker pens
- Pencils
- Colour pencils
- Scale
- Eraser
- Other requisite stationery material

Ask

- Do you think that entrepreneurs need support?
- What do you think is an eco-system?
- What do you think 'entrepreneurship support eco-system' means?

Say

- Let's learn what entrepreneurship support eco-system means.
- Discuss 'Entrepreneurship Support Eco-System' as given in the Participant Handbook.

Ask

- Can you define entrepreneurship support eco-system?
- What are the key domains of the support eco-system?

Say

- Let's learn more about these domains by conducting an activity.
- You have to make a poster showing the components of the six main domains of entrepreneurship support eco-system.

Team Activity

- Making a poster showing the entrepreneurship support eco-system.

Do 

- Divide the class into groups of four or six.
- Hand out chart paper and coloured pens.
- Explain the purpose and duration of the activity.
- Go around checking the progress of each group.
- Set guidelines pertaining to discipline and expected tasks.

Activity De-brief

Ask each group to display their poster and explain the key domains of entrepreneurship support eco-system.

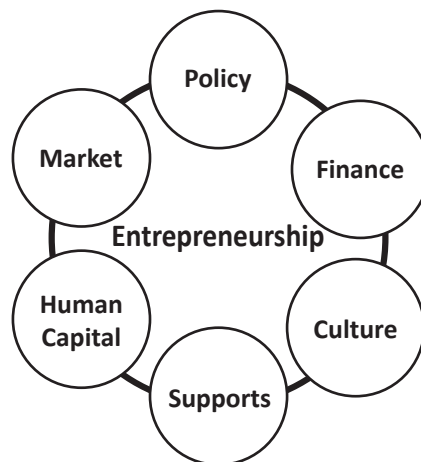
Ask 

- What kind of government support eco-system is available for entrepreneurs in India?

Say 

- Discuss 'Make in India' campaign as given in the Participant Handbook.

Team Activity 

- Presentation on key schemes to promote entrepreneurs

Do 

- Divide the class into pairs.
- Number each pair from 1-15.
- Assign a scheme, same as their group number, to each group.
- Ask them to read the scheme carefully and present it to the class.
- Explain the purpose and duration of the activity.
- Go around checking the progress of each group.
- Set guidelines pertaining to discipline and expected tasks.

Activity De-brief

- Ask each group to explain the scheme offered by government to promote entrepreneurs.

Summarize 

- Summarize the unit by discussing the key points and answering questions the participants may have.

UNIT 9.5.7: Risk Appetite & Resilience

Unit Objectives

At the end of this unit, participants will be able to:

- Discuss the relationship between entrepreneurship and risk appetite
- Discuss the relationship between entrepreneurship and resilience
- Describe the characteristics of a resilient entrepreneur

Resources to be Used

- Participant Handbook
- Chart papers
- Blank sheets of paper
- Pens
- Marker pens

Ask

- Can you define risk or explain what constitutes a risk?
- What do you people mean when they say, “This may be a risky proposition”?
- What risks are they talking about?

Example

- Let's have a look at these two examples:

Rohit and his family were travelling by car from Delhi to Nainital. It was their second trip there. Rohit was familiar with the road. His friends told him that the highway after Rampur was in a bad condition. They advised him to take a shortcut and turn left from Moradabad and take the Kaladhungi road. This road is in a better condition.

Since he was going with his family, and did not want to take the risk of getting lost, he left early. He took the Kaladhungi road and reached Nainital well in time.

Suresh and his family too were travelling by car from Delhi to Nainital. It was their second trip there. His friends too advised him to take a shortcut and turn left from Moradabad and take the Kaladhungi road as this road was in a better condition.

Suresh too decided to take the Kaladhungi road but he left Delhi in the afternoon. It was dark by the time he reached Kaladhungi, and he was sure that he was taking the correct turn. As it was late, he could not find anyone to give him directions. He ended up being in an unknown place that was scarcely inhabited.

Say

- Let's see what type of risks Rohit and Suresh took.
- Discuss 'Risk Appetite and Resilience' with the participants as given in the Participant Handbook.

Say

- Let's learn more about risk appetite and resilience with the help of an activity.

Team Activity

Risk Appetite

- This is a group activity.

- In the previous unit, you read success stories of Mr Dhirubhai Ambani and Dr Karsanbhai Patel.
- Mr Ambani left his job and started his company Reliance with just Rs. 50,000/-.
- Dr Patel kept his job, went door-to-door to sell Nirma, and only when the brand started gaining popularity did he start his own company.
- What types of risk did both of them take?
- What risk factors, do you think, did they keep in mind before launching their company?
- Write the Risk Appetite Statement of both the companies.

Activity De-brief

- Who took a greater risk?
- What are the differences between the Risk Appetite Statement of both the companies?

Do

- Instruct the participants that this is group work.
- Divide the class into small groups of 4.
- Give each group a chart paper.
- Tell the participants that they have to evaluate the risks taken by Mr Dhirubhai Ambani and Dr Karsanbhai Patel.
- Give the participants 15 minutes to discuss and write.
- Keep a check on time. Tell the group to wind up quickly if they go beyond the given time limit.

Ask

- Do you think all entrepreneurial ventures are successful?
- What happens if the first venture is not successful?
- Should the entrepreneur stop when faced with challenges or face them?

Example

- Let's have a look at the following example:

Vijay Shekhar Sharma is the founder of Paytm, which is a giant Indian e-commerce. He was born in a middle-class family in Uttar Pradesh. He started his first job at an MNC. He quit after six months and built a company One97 with his friends. As One97 grew bigger, it needed more money because it was running more servers, bigger teams, and had to pay royalty. At that time, the tech bubble popped and technology companies were running in losses. Finally, money ran out. So One97 took loans and then more loans at higher rates of interest, as high as 24 per cent, and became caught in a vicious cycle.

In 2014, Paytm was launched with online wallet services after which, the company enabled online payment transactions. The company got licenses from RBI in 2016 to launch India's first ever payment bank. Moreover, the main motive of Paytm was to transform India into a cashless economy.

After demonetization came into effect, Vijay Shekhar Sharma started promoting online and digital transactions to deal with the cash crunch. In fact, the service of the company's mobile wallet is accepted across India. The logo of Paytm is now popular almost everywhere from tea stalls to major companies.

Say

- Let's see what qualities made Vijay Shekhar Sharma a resilient entrepreneur.
- Discuss Entrepreneurship and Resilience with the participants as given in the Participant Handbook.

Say

- Let's learn more about entrepreneurship and resilience with the help of an activity.

Team Activity

Entrepreneurship and Resilience

- This is a group activity.
- Think of some entrepreneurship ventures that faced challenging times, but later resulted in success stories.
 - Who is the founder of that company?
 - What challenging times did it face?
 - How did it overcome those challenges?
 - List the resilient characteristics of the entrepreneur.

Activity De-brief

- Each group to give their presentation.
- Why did you choose this company?
- What is the success story of the company?

Do

- Instruct the participants that this is group work.
- Divide the class into small groups of 4.
- Give each group a chart paper.
- Tell the participants that they have to think of an entrepreneur who faced challenging times, but eventually succeeded.
- Give the participants 15 minutes to discuss and write.
- Keep a check on time. Tell the group to wind up quickly if they go beyond the given time limit.

Summarize

- You can summarize the key points of the unit.
- Ask the participants what they learned from the activities.
- Clarify any questions or doubts they might have.

UNIT 9.5.8: Success and Failures

Unit Objectives

At the end of this unit, participants will be able to:

- Discuss how to deal with failure

Resources to be Used

- Participant Handbook

Ask

- Have you heard the quote 'nothing is impossible'?
- What do you think it means?
- Do you think that all successful entrepreneurs became famous overnight or did they have to struggle or face failure before succeeding?

Example

- Let's have a look at this example.

Shah Rukh Khan, also known as, SRK or King Khan is a force to reckon with. Did he achieve stardom overnight? Shah Rukh Khan, who has seen many struggles in his life – he has slept on streets, struggled to support himself and his sister at a very young age, and lost his parents very early in life, which led to his sister seeking mental health support. Amidst all the chaos and challenges, he kept pushing himself, and today he stands tall as the 'Badshah of Bollywood'. Certainly those years were not easy for him.

When he was young, he stood at Marine Drive and said, "I will rule this city one day". Failure was not just his companion during or before his stardom, it is still a substantial part of his life. Success does not come easy. What made him a star was his acceptance of failure and the urge to improve.

Say

- How do you define success and failure?
- What is fear?
- Discuss "success and failure" with the participants as given in the Participant Handbook.

Ask

- Have you felt or experienced fear?
- What led you to feel that emotion?
- How did you handle it?

Say

- Let's learn the about success and failure with the help of an activity.

Team Activity

- Divide the class into groups of four.
- Instruct them to think of one scenario where they have to interview a successful entrepreneur.
- Explain the purpose and duration of the activity.
- Set guidelines pertaining to discipline and expected tasks.
- They have to choose one person from the group as the interviewee and one as the interviewer.
- Go around and make sure they have understood what is to be done and are discussing the roles properly.
- Check that everyone understands their role. Give clarifications if needed. Give the participants about 5 minutes to discuss and decide their roles.
- Ask the groups to stop the discussion as soon as the time is over.
- Invite each group one by one to come and present their interview as a role play.

Notes for Facilitation

Facilitating Role Plays

Preparing for the activity

1. Carefully review the details of the scenario and the character descriptions.
2. Become familiar with the key issues being addressed in the scenario.
3. Study the provided material so that you are ready to address issues related to the situations depicted in the role plays.
4. Anticipate potential questions that might be raised by the participants and be ready to address them.

Conducting the activity

1. Introduce the activity. Emphasize that role playing provides participants with an opportunity to apply their new knowledge, skills, and tools in situations that simulate actual interactions with customers.
2. Ask participants to form pairs. Direct the members of each group to choose who will play the roles. Remind the groups that each participant should be given the opportunity to play/practice the different roles.
3. Conduct a demonstration so that participants become familiar with the expectations related to the roles and support materials.
4. To maintain spontaneity of the interactions during the role play, ask the participants not to discuss the details of their roles prior to the role play.
5. Give the pairs 15-20 minutes to conduct the role play.
6. Circulate among the groups to answer any questions that may arise and provide guidance as needed.
7. After all the pairs have finished with the role play, conduct a de-briefing session on each role play.
8. Ask the groups to take five minutes to talk about what happened during the role play. The groups should discuss the questions given in the de-briefing for each role play. Encourage participants to provide constructive criticism during their discussions.
9. Conclude the activity by asking participants to think about whether and how they might use scripted role plays in their real life.

Summarize

- Wrap the unit up after summarizing the key points and answering questions.

UNIT 9.6: Preparing to be an Entrepreneur

Key Learning Outcomes



At the end of this unit, participants will be able to:

1. Discuss how market research is carried out
2. Describe the 4 Ps of marketing
3. Discuss the importance of idea generation
4. Recall basic business terminology
5. Discuss the need for CRM
6. Discuss the benefits of CRM
7. Discuss the need for networking
8. Discuss the benefits of networking
9. Discuss the importance of setting goals
10. Differentiate between short-term, medium-term and long-term goals
11. Discuss how to write a business plan
12. Explain the financial planning process
13. Discuss ways to manage your risk
14. Describe the procedure and formalities for applying for bank finance
15. Discuss how to manage their own enterprise
16. List the important questions that every entrepreneur should ask before starting an enterprise

UNIT 9.6.1: Market Study/ The 4Ps of Marketing/ Importance of an IDEA: Understanding Market Research

Unit Objectives

At the end of this unit, participants will be able to:

- Discuss how market research is carried out
- Describe the 4 Ps of marketing
- Discuss the importance of idea generation

Resources to be Used

- Participant Handbook
- Chart papers
- Markers pens
- Blank sheets of paper

Ask

- Suppose, you want to open a restaurant, what are the factors you will consider?
- How will you promote your restaurant?

Example

- Let's have a look at this example.

Arjun was an MBA working in a company. But he wanted to start a low cost budget hostel for foreign tourists coming to India. He did a lot of market research before starting the project. Based on the information he gathered, he made his business plan. His hostel is now flourishing and he is thinking of expanding to other tourist destinations.

Say

- Discuss “Market Study” with the participants. Refer to the Participant Handbook.
- Let's learn about market study and research with the help of an activity.

Team Activity

Market Study

- This is a group activity.
- You want to start your own tuition centre.
- What type of research will you do?

Activity De-brief

- Ask each group to come forward and give a brief presentation.
- Encourage other groups to be interactive and ask questions.
- What factors did you keep in mind while doing your research?
- Based on our research would you go ahead and open a tuition centre?

Do 

- Instruct the participants that this is group work.
- Divide the class into small groups of 4 or 6.
- Give each group a chart paper.
- Tell the participants that they have to start their own tuition centre.
- Give the participants 10 minutes to discuss and write the research work they need to do.
- Keep a check on time. Tell the group to wind up quickly if they go beyond the given time limit.

Say 

- By opening a tuition centre you are offering a service.

Ask 

- What factors will you keep in mind before opening it?

Say 

- Discuss “The 4Ps of Marketing” with the participants as given in the Participant Handbook.

Say 

- Let's learn about the 4Ps of Marketing with the help of an activity.

Team Activity **4 Ps of Marketing**

- This is a group activity.
- You have to sell a pen to four different segments:
 1. Rural villagers
 2. Rural middle class
 3. Urban middle class
 4. Upper end rich people (Niche market)

Keeping the 4Ps of Marketing in mind, what marketing strategy will you design to sell the pen?

Activity De-brief

- Ask each group to present their strategy.
- Encourage other groups to be interactive and ask questions.

Do 

- Instruct the participants that this is group work.
- Divide the class into four groups.
- Give each group a chart paper.
- Assign each group a target audience for selling the pens:
 1. Rural villagers
 2. Rural middle class
 3. Urban middle class

4. Upper end rich people

- Tell the participants that they have to design a marketing strategy keeping the 4Ps of Marketing in mind.
- Give the participants 20 minutes to discuss and come up with their strategy.
- Keep a check on time. Tell the group to wind up quickly if they go beyond the given time limit

Activity De-brief

- Ask each group to come forward and give a brief presentation.
- Ask each group what they kept in mind while designing their marketing strategy.
- Encourage other groups to be interactive and ask questions.

Say

- Each entrepreneur has an idea of wants he wants to sell. It may be a service or a product.
- Discuss “Importance of an IDEA” as given in the Participant Handbook.

Summarize

- Summarize the key points of the unit.
- Ask the participants what they learnt from the activities.
- Encourage them to ask if they have any doubts.

UNIT 9.6.2: Business Entity Concepts

Unit Objectives

At the end of this unit, participants will be able to:

- Recall basic business terminology

Resources to be Used

- Participant Handbook

Say

- Let's recall some basic business terminology.
- Discuss the Business Entity Concepts as given in the Participant Handbook.
- Let's learn some basic business terminology by having an activity.
- We will have a quiz today.

Activity

- The activity is a quiz.

Do

- Divide the class in two groups and give a name to each group.
- Explain the rules of the quiz. For each correct answer the group gets 1 mark.
- If the group is unable to answer the question is passed to the next group.
- Explain the purpose and duration of the activity.
- Ask the questions of the quiz.
- Keep a score of the groups.
- Set guidelines pertaining to discipline and expected tasks.

Summarize

- Summarize the unit by discussing the key points.

Notes for Facilitation

QUESTIONS FOR THE QUIZ

1. What does B2B mean?
Business to business
2. What is a financial report?
A comprehensive account of a business' transactions and expenses
3. Who is a sales prospect?
A potential customer
4. How is working capital calculated?
Current assets minus current liabilities

5. What is an estimation of the overall worth of a business called?
Valuation
6. You are buying a house. What type of transaction is it?
Complex transaction
7. How will you calculate the net income?
Revenue minus expenses
8. How is Return on Investment expressed?
As percentage
9. How will you calculate the cost of goods sold?
Cost of materials minus cost of outputs
10. What is revenue?
Total amount of income before expenses are subtracted.
11. What is a Break-Even Point?
This is the point at which the company will not make a profit or a loss. The total cost and total revenues are equal.
12. What is the formula used to calculate simple interest?
 $A = P(1 + rt); R = r * 100$
13. What are the three types of business transactions?
Simple, Complex and Ongoing Transactions
14. The degrading value of an asset over time is known as
Depreciation
15. What are the two main types of capital?
Debt and Equity

UNIT 9.6.3: CRM & Networking

Unit Objectives

At the end of this unit, participants will be able to:

- Discuss the need for CRM
- Discuss the benefits of CRM
- Discuss the need for networking
- Discuss the benefits of networking

Resources to be Used

- Participant Handbook

Ask

- Can your business run without customers/buyers?
- Who is the most important entity in any business?

Say

- The key to every success business lies on understanding the customer's expectations and providing excellent customer service.
- Discuss about CRM and its benefits. Refer to the Participant Handbook.
- Providing excellent customer service entails:
 - ♦ Treating your customers with respect.
 - ♦ Be available as per their need/ schedule.
 - ♦ Handling complaints effectively.
 - ♦ Building long lasting relationships.
 - ♦ Collecting regular feedback.
- Handle customer complaints proactively. Ask “what happened”, “why it happened”, “how can it be avoided next time”, etc.
- Collecting feedback from the customers regularly will enable you to improve your good/service.
- “Let's understand it better with the help of some case scenarios. You will be given some cases within your groups. You have to analyse the case scenario that has been given to you and then find an appropriate solution to the problem.”

Do

- Divide the class into four groups of maximum six participants depending on the batch size.
- Give one case study to each group.
- Instruct them to read the case carefully.
- The group is expected to analyse and discuss the case amongst them and find a solution to the given problem.
- Put down the discussion points (de-brief questions) on the board. Give the class 5-10 minutes to discuss the case and note down their solutions.
- At the end of 10 minutes, the team should present their case solution to the class.

Team Activity

Case Study Analysis

Raju runs a business of wooden furniture. He has a huge list of customers on Facebook and WhatsApp who give him orders regularly. Ankita is one of his old and regular customers. She placed an order for a new chester and TV cabinet via WhatsApp and requested Raju to send them as soon as possible. When the parcel reached Ankita through courier she found that chester was broken and the TV unit was chipped from the bottom. Ankita was heartbroken. It was a complete waste of money. She sent a message to Raju on WhatsApp, expressing her anger and disappointment. Raju might lose an old customer forever if he doesn't satisfy the customer. What should Raju do to retain his customer?

Scenario 2

Rajni runs a boutique shop. She sells suits and sarees. She is one of the most successful designer in her city. Rajni swears that all the clothes in her boutique have unique designs. Smita has to attend her cousin's wedding; she goes to Rajni's boutique to buy a saree. Smita wanted a unique designer saree. Rajni customized a saree for her and sent it over the courier. When Smita had a look at the saree she realised her two friends had the same design sarees. She sent a message to Rajni on WhatsApp, expressing her anger and disappointment. Did Rajni make a false promise? Were her designs copied? What could happen to Rajni's image after this incident? What would you do if you were in Rajni's place?

Scenario 3

Shama is a beautician who offers parlour services to ladies by making home visits. Recently, Shama got her name registered on an e-commerce website. Two days earlier, she got a message from Mrs Sushma. The appointment was fixed for next day, 11:00 am and the remuneration for the services was decided beforehand. When Shama reached there at 10:50 am, Mrs Sushma was not at home. When Shama called her, she asked her to wait for a while. Mrs Sushma reached home at 11:45 am. Meanwhile, Shama had to reschedule her next appointment. After availing Shama's services, Mrs Sushma refused to pay the requisite amount and started finding faults in the services provided by her. Who was at fault in this scenario? What should you do in case the customer behaves unreasonably? What would you do if you were in Shama's place?

Scenario 4

Shailender is the manager of a car showroom. He proactively takes part in all the transactions that happen in his showroom. Vinita wants to buy a new car. She has chosen a car from Shailender's showroom. The salesperson has given her a very good discount and has also promised free service for one year. Vinita goes to the showroom and asks to complete all the formalities to purchase the car. When she sees the final bill she realize that she has not received the promised discount neither was there any mention of the free services. She immediately demands to see the Shailender. When Shailender's head asks how much discount Vinita was promised, he realised the discount will make the sale in loss. The car showroom owner might lose a customer and deal due to false commitments made by his manager. Besides, the customer might tell this to other people, creating a bad name and image for the showroom. If you owned that showroom, how would you have convinced your customer?

Say

- Now, let's discuss the problem and solution with the class.
- The group will first briefly describe the case to the class.
- Then discuss the issue identified and the proposed solution.
- Present the solution as a role play.
- Post presentation, the other groups may ask questions from the group that has presented.

Do 

- Congratulate each group for the presentation/ role play.
- Ask the audience to applaud for them.
- Keep a check on time. Tell the group to wind up the discussion quickly if they go beyond the given time limit.

Say 

- If your customers are happy with you they will give referrals which will help to grow your business.
- One more way of growing business is 'Networking'.
- Discuss Networking and its benefits. Refer to the Participant Handbook.

Activity 

Group Discussion

- Conduct a group discussion in the class on how they can do networking for their business.

Summarize 

- Ask the participants what they have learnt from this exercise/ activity.
- Ask if they have any questions related to what they have talked about so far.
- Close the discussion by summarizing the importance of CRM and Networking for entrepreneurs.
- Close the discussion by summarizing the importance of CRM and Networking for entrepreneurs.

UNIT 9.6.4: Business Plan: Why Set Goals?

Unit Objectives

At the end of this unit, participants will be able to:

- Discuss the importance of setting goals
- Differentiate between short-term, medium-term and long-term goals
- Discuss how to write a business plan
- Explain the financial planning process
- Discuss ways to manage your risk

Resources to be Used

- Participant Handbook
- Chart papers
- Blank papers
- Marker pens
- Ruler

Ask

- Remember we had written SMART Goals in a previous session? Let's try and recall why it is important to set goals?
- While framing SMART goals, we talked about 'T' in SMART, which was 'Time Bound'? What do we mean by time bound goals?
- What time limit did you set for your goal- 3 weeks, 3 years, 10 years?

Say

- Talk about short term, long term and medium term goals, as discussed in the Participant Handbook.

Ask

- As you are planning to become an entrepreneur, you must have thought of an idea for a start-up. What is your business idea?

Do

- Ask few participants to share their business ideas.

Ask

- Have you created a business plan for your business idea?
- Do you think it is important to have a business plan in place? Why/ why not?

Say

- Talk about 'Why Create a Business Plan' as discussed in the Participant Handbook.
- Let's understand it better with the help of an activity.

Team Activity

Writing a business Plan

- This is a group activity.
- Give the groups the required resources such as chart paper and markers.
- This activity is divided into two parts:
 1. Create a business idea
 2. Develop a business plan
- The group will discuss and come up with a new business idea and present their idea to the class.
- In the second part of the activity the group will develop a business plan for the business idea.
- The business plan prepared will be presented by the groups to the class.

MY BUSINESS PLAN
Executive Summary: What is your Mission Statement?
Business Description: What is the nature of your business?
Market Analysis: What is your target market?
Organization and Management: What is your company's organizational structure?
Service or Product Line: What is the lifecycle of your product/ service?
Marketing and Sales: How will you advertise and sell your products?
Funding Request: How much fund is required and from where?

Say

- Teams will need to brainstorm for this part of the activity.
- Use the blank papers for the second part of this activity
- Make your business plan on a chart paper based on the following parameters:
 1. Executive Summary
 2. Business Description
 3. Market Analysis
 4. Organization and Management
 5. Service or Product Line
 6. Marketing and Sales
- Explain each parameter in detail as done in the Participant Handbook.
- Discuss each parameter with the business idea examples of the groups.
- Groups will discuss and develop the business plan for their business idea.

Say 

- Now, let's share our plan with the class.
- Each group will briefly describe the plan to the class.
- Post presentation, the other groups may ask questions to the group who have presented their plan.

Do 

- Congratulate each group for sharing their points.
- Ask the audience to applaud for them.
- Keep a check on time. Tell group to wind up the discussion quickly if they go beyond the given time limit.

Say 

- Along with a business plan, you need to create a financial plan and evaluate the risk involved with your start up.
- Discuss 'Financial Planning' and 'Risk Management' in detail as given in the Participant Handbook.

Summarize 

- Ask the participants what they have learnt from this exercise/ activity.
- Ask if they have any questions related to what they have talked about so far.

Notes for Facilitation 

- Keep the business plan format ready in a flipchart to display it during the activity.

UNIT 9.6.5: Procedures and Formalities for Bank Finance

Unit Objectives

At the end of this unit, participants will be able to:

- Describe the procedure and formalities for applying for bank finance

Resources to be Used

- Participant Handbook
- Bank loan/finance form sample

Ask

- While preparing a business plan in the last session, we discussed financial planning to arrange financial resources for your start-up. Therefore, how will you collect funds to start your business?

Say

- While most entrepreneurs think 'product' is the most difficult thing to decide for a business, start-up capital poses an even a bigger obstacle. Though there are various ways of funding the business, to convince investors to invest money is the most challenging.
- Some of the funding options available in India are:
 - ♦ **Bootstrapping:** Also called self-financing is the easiest way of financing
 - ♦ **Crowd funding:** Funds are collected by consumers pre-ordering or donating for starting the business.
 - ♦ **Angel investors:** Individual or group of investors investing in the company
 - ♦ **Venture capitalists:** Venture capitals are professionally managed funds who invest in companies that have huge potential. They usually invest in a business against equity.
 - ♦ **Bank loans:** The most popular method in India.
 - ♦ **Microfinance Providers or NBFCs**
 - ♦ **Government programmes**
- Let us know discuss the most popular method i.e. bank finance in detail here.

Do

- Discuss the list of documents that are required to apply for a loan like letter of introduction, business brochure, references of other banks, and financial statements.
- Explain the details to be filled in a loan application form.
- Divide the class into groups. Give each group a loan application form.
- Ask the groups to discuss and fill the form.

Summarize

- Close the discussion by summarizing the important documents needed for bank loan.
- Ask the participants if they have any questions related to what they have talked about so far.

Notes for Facilitation

- Checklist of documents is provided as resources for the session.
- You can make some copies and distribute it during the group activity.
- Download sample loan application forms from any nationalised bank's website. Print sufficient copies to circulate it amongst the groups.

CHECKLIST OF DOCUMENTS TO BE SUBMITTED ALONG WITH LOAN APPLICATION (Common for all banks)
1. Audited financial statements of the business concern for the last three years
2. Provisional financial statements for the half – year ended on _____
3. Audited financial statements of associate concern/s for the last three years
4. Copy of QIS II for the previous quarter ended on _____
5. Operational details in Annexure I
6. CMA data for the last three years, estimates for current year and projection for the next year
7. Term loan/DPG requirements in Annexure II
8. List of machinery in respect of machinery offered as security in Annexure III
9. Additional details for export advances furnished in Annexure IV
10. Property statements of all directors/partners/proprietor/guarantors
11. Copies of ITAO of the company for the last three years
12. Copies of ITAOs/WTAOs of the directors/partners/proprietor and guarantors
13. Copies of certificate from banks and financial institutions certifying the latest liability with them
14. Copy of board resolution authorizing the company to apply to your bank for the credit facilities mentioned in application
15. Copy of memorandum and article of association (in case of limited company)/partnership deed (in case of partnership firm)
16. Cash budget for the current year and next year in case of contractors and seasonal industries

UNIT 9.6.6: Enterprise Management – An Overview: How to Manage Your Enterprise?

Unit Objectives

At the end of this unit, participants will be able to:

- Discuss how to manage their own enterprise

Resources to be Used

- Participant Handbook

Ask

- Having set-up a business, do you think it is possible to do everything on your own?
- Does one require trained persons for help?
- What does management mean?

Say

- Let's have a look at this example:

Kapil had a small business that was beginning to pick up pace. He wanted to expand his business, and therefore employed few more people. One day, as he was walking past Ramesh, one of his new employees, he overheard Ramesh talking rudely to a customer on the phone. This set him thinking. Kapil realised that he should have regular team meetings to motivate his employees and speak with them about any problems they might be facing during work. He should also conduct training sessions on new practices, soft skills, and technology, and develop work ethics manual for managing his enterprise.

Say

- Was Kapil correct in his approach or he should have scolded Ramesh instantly in front of his other employees?
- Discuss “Enterprise Management – An Overview” with the participants as given in the Participant Handbook.

Say

- Let's learn how to effectively manage an enterprise or business through an activity.

Team Activity

Enterprise Management

- This is a group activity.
- Design a matrix listing the topics and key words that are needed to run an enterprise effectively and smoothly.

Activity De-brief

- Have each group present their matrix.
- Encourage participants of the other groups to ask question about each other's presentation.

Do 

- Instruct the participants that this is group work.
- Divide the class into small groups of 4.
- Give each group a chart paper and coloured pen.
- Tell the participants that they have to make a matrix they need to fill.
- They have to write the main topics and key words that will help them effectively manage their enterprise.
- Give the participants 15 minutes to discuss and write.
- Keep a check on time. Tell the group to wind up quickly if they go beyond the given time limit.

Summarize 

- Ask the participants what they have learned from this exercise/activity.
- Ask if they have any questions related to what they have talked about so far.
- Close the discussion by summarizing the importance of effective management to run an enterprise as given in the Participant Handbook.

UNIT 9.6.7: 20 Questions to Ask Yourself before Considering Entrepreneurship

Unit Objectives

At the end of this unit, participants will be able to:

- List the important questions that every entrepreneur should ask before starting an enterprise

Resources to be Used

- Participant Handbook
- Blank sheets of paper
- Pens

Ask

- Why do you want to become an entrepreneur?

Say

- It is very important to know why you want to become an entrepreneur. Your personal goals for becoming an entrepreneur play a key role in the success of your business. Your goals should be clear well before you start your business.
- Apart from the goals, the other aspects of business that you need to bear in mind are the potential problems that you may face to set-up, your areas of interest, and all the other dimensions of the business.
- Let's understand it better with the help of some questions that every entrepreneur should ask before starting their own business.
- Open the Participant Handbook section named '20 Questions to Ask Yourself Before Considering Entrepreneurship'. You have to answer the questions individually.
- Then, we will have a class discussion on all the questions.

Do

- Read out the questions one by one in front of all the participants.
- Participants have to answer all the one by one questions.
- Give the class 10-15 minutes to note down their answers.
- At the end of 15 minutes, open the discussion for all the questions.
- Moderate the discussion by focusing on the relevant points.
- Keep a check on time and don't let the discussion get sabotaged or lose track of time. Ensure all the questions are covered and discussed.

Summarize

- Ask the participants what they have learned from this exercise/activity.
- Ask if they have any questions related to what they have talked about so far.



Skill India
कौशल भारत - कुशल भारत



सत्यमेव जयते
GOVERNMENT OF INDIA
MINISTRY OF SKILL DEVELOPMENT
& ENTREPRENEURSHIP



N S D C
National
Skill Development
Corporation

Transforming the skill landscape



10. Annexure

Annexure I: Training Delivery Plan

Annexure II: Assessment Criteria

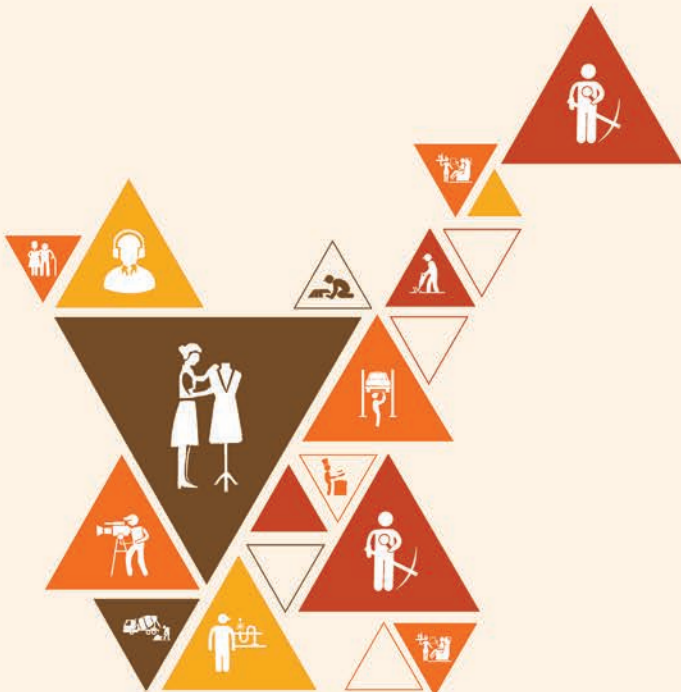

Annexure I

Training Delivery Plan

Training Delivery Plan			
Program Name:	Sewing Machine Operator		
a Pack Name & Ref. ID	AMH/Q 0301		
Version No.	1.0	Version Update Date	11/07/14
Pre-requisites to Training	5th Standard		
Training Outcomes	<p>By the end of this program participants will be able to:</p> <ol style="list-style-type: none"> 1. Carry out sewing tasks by hand 2. Contribute to achieve product quality in sewing operation 3. Maintain work area, tools and machines 4. Maintain health, safety and security at workplace 5. Comply with industry, regulatory and organizational requirements 		

Sl. No.	Module Name	Session Name	Topics	NOS Reference	Methodology	Training Tools/Aids	Duration
1.	Intr Orienta	Intr to Sewing and Apparel Sector	Theory 1. Overview of Apparel Industry 2. What are Ready Made Garments/Madeups	Bridge Module	<ul style="list-style-type: none"> Facilitator-led – Discussion 	PPT, Handbooks, Audio Visual Clips	1:00 hrs.
		Roles and r Sewing Machine Operator	Theory 1. Job Descrip 2. Roles and r of SMO	Bridge Module	<ul style="list-style-type: none"> Power-point presenta Facilitator-led - discussion Audio-visuals Images 	PPT, Handbooks, Audio Visual Clips	1:00 hrs.
2.	Carry out ching machine or by hand	Prepare for s ching opera	Theory 1. Parts of a Sewing Machine 2. erent types of Sewing Machine	AMH/N0301	<ul style="list-style-type: none"> Facilitator-led – Discussion Use images and descrip en in the P t's Handbook 	PPT, P t Handbook, Audio Visual Clips, Sewing Machine	2:00 hrs.
			Pr al <ul style="list-style-type: none"> Iden a erent Machine Parts Prec o be taken while se sewing machine 	AMH/N0301	<ul style="list-style-type: none"> Facilitator-led ques wer sessions Demonstra using a sewing machine 	PPT, P t Handbook, Audio Visual Clips, Sewing Machine	1:00 hrs.
			Theory 1. Machine Feed Mechanism	AMH/N0301	<ul style="list-style-type: none"> Facilitator-led – Discussion Use images and descrip en in the P t's Handbook 	PPT, P t Handbook, Audio Visual Clips, Sewing Machine	2:00 hrs.
			Pr al <ul style="list-style-type: none"> Create an understanding of how the machine works 	AMH/N0301	<ul style="list-style-type: none"> Demonstra using a sewing machine 	PPT, P t Handbook, Audio Visual Clips, Sewing Machine	2:00 hrs.
			Theory 1. Tools used in Sewing Processes	AMH/N0301	<ul style="list-style-type: none"> Facilitator-led – Discussion Use images and descrip en in the P t's Handbook Use the tool bank to draw parallels 	PPT, P t Handbook, Audio Visual Clips, Sewing Tool Kit	2:00 hrs
		ch components to produce apparels	Theory 1. Type of Needle & Threads	AMH/N0301	<ul style="list-style-type: none"> Facilitator led discussions Demonstrate what happen when wrong thread-fabric-needle combina used 	PPT, P t Handbook, Audio Visual Clips, Fabric Swatches, erent thickness of thr erent thread	2:00 hrs.
			Theory 1. Familiariz erent fabrics and their s ch compa	AMH/N0301	<ul style="list-style-type: none"> Facilitator led discussions Demonstrate what happen when wrong thread-fabric-needle combina used 	PPT, P t Handbook, Audio Visual Clips, Fabric Swatches, erent thickness of thr erent thread	2:00 hrs.

			<p>Practical</p> <ul style="list-style-type: none"> How to use bobbin winder Replacing a Needle Threading the machine 	AMH/N0301	<ul style="list-style-type: none"> Demonstrating sewing machine 	PPT, Facilitator Guide, Audio Visual Clips, Bobbin, Bobbin case, Needle, Thread	2:00 hrs.
			<p>Theory</p> <ol style="list-style-type: none"> Create an understanding of Practical and expected outcomes 	AMH/N0301	<ul style="list-style-type: none"> Trainer led discussion 	PPT, Handbooks, Audio Visual Clips	2:00 hrs.
			<p>Theory</p> <ol style="list-style-type: none"> Garment & its parts 	AMH/N0301	<ul style="list-style-type: none"> Trainer led discussion Identifying garment parts using a garment 	PPT, Practical Handbook, Audio Visual Clips, Various Garments (Trouser, shirt etc)	2:00 hrs.
			<p>Practical</p> <ul style="list-style-type: none"> Learning to control machine speed Learning to start and stop the sewing machine 	AMH/N0301	<ul style="list-style-type: none"> Practical Lab (Paper exercise without thread) 	Paper, Pen, sewing machine, needle	6:00 hrs.
			<p>Practical</p> <ul style="list-style-type: none"> Learning to sew in short and long straight lines 	AMH/N0301	<ul style="list-style-type: none"> Paper exercise without thread) 	Paper, Pen, sewing machine, needle	6:00 hrs.
			<p>Theory</p> <ol style="list-style-type: none"> Knowing different types of stitching and seam. 	AMH/N0301	<ul style="list-style-type: none"> Power-point presentation Facilitator-led discussion Audio-visuals Clips 	PPT, Computer, Projector	2:00 hrs.
			<p>Theory</p> <ol style="list-style-type: none"> Create and understanding of the steps involved in locking 	AMH/N0301	<ul style="list-style-type: none"> Power-point presentation Facilitator-led discussion Audio-visuals Clips 	PPT, Facilitator Guide, Computer, Projector	2:00 hrs.
			<p>Practical</p> <ul style="list-style-type: none"> Perform test run for locking on Paper 	AMH/N0301	<ul style="list-style-type: none"> Practical Lab Paper exercise with thread, Use straight line exercise 	Facilitator Guide, Paper, Pen, sewing machine, thread, needle, Bobbin, Bobbin case	6:00 hrs
			<p>Practical</p> <ul style="list-style-type: none"> Practising on Fabric at an acceptable speed Learning fabric handling while stitching 	AMH/N0301	<ul style="list-style-type: none"> Practical Lab Use straight line exercise Demonstrate what can happen if fabric is not handled correctly 	Fabric, Pencil, Pen, sewing machine, thread, needle, bobbin, bobbin case, Handbooks	6:00 hrs.
			<p>Practical</p> <ul style="list-style-type: none"> Practising 	AMH/N0301	<ul style="list-style-type: none"> Practical Lab Demonstrate and let the learner's practice 	Fabric, Pencil, Pen, sewing machine, thread, needle, bobbin, bobbin case, Handbooks	6:00 hrs.
			<p>Practical</p> <ul style="list-style-type: none"> Practising 	AMH/N0301	<ul style="list-style-type: none"> Practical Lab Demonstrate and let the learner's practice 	Fabric, Pencil, Pen, sewing machine, thread, needle, bobbin, bobbin case, Handbooks	6:00 hrs.
			<p>Theory</p> <ol style="list-style-type: none"> Different types of Seams and where are they used 	AMH/N0301	<ul style="list-style-type: none"> Trainer led discussion 	PPT, Handbook, Examples	2:00 hrs.

			<p>Practical</p> <ul style="list-style-type: none"> Aligning fabric panels together Prerent seams 	AMH/N0301	<ul style="list-style-type: none"> Demonstrate the stitching procedure of various seams Demonstrate alls of improperly aligned seams 	Fabric ,Pencil, Pen, sewing machine, thread, needle, bobbin, bobbin case, Handbooks, Pins	6:00 hrs.
		ching a Trouser	<p>Theory</p> <ol style="list-style-type: none"> Familiarize with Trousers Components in a Trouser 	AMH/N0301	<ul style="list-style-type: none"> Trainer Led Discussion 	PPT, P t Handbook, Pen , Pencil, Trouser	2:00 hrs
			<p>Theory</p> <ol style="list-style-type: none"> Types of Trousers Seams in a Trouser 	AMH/N0301	<ul style="list-style-type: none"> Trainer Led Discussion 	PPT, P t Handbook, Pen , Pencil, Trouser	2:00 hrs
			<p>Theory</p> <ol style="list-style-type: none"> Trims used in Trouser 	AMH/N0301	<ul style="list-style-type: none"> Trainer Led Discussion 	PPT, Pen , Pencil, Trouser	2:00 hrs.
			<p>Theory</p> <ol style="list-style-type: none"> How is a Trouser Sewn (ching Sequence) 	AMH/N0301	<ul style="list-style-type: none"> Trainer Led Discussion 	PPT, P t Handbook/ Facilitator Guide, Pen , Pencil, Trouser	2:00 hrs.
			<p>Practical</p> <ul style="list-style-type: none"> Prepara a achment of Front Pocket 	AMH/N0301	<ul style="list-style-type: none"> ching Procedure Demonstra Ask the learner to think about sewing defects that can arise 	Fabric ,Pencil, Pen, sewing machine, thread, needle, bobbin, bobbin case, P t Handbook/ Facilitator Guide	5:00 hrs.
			<p>Practical</p> <ul style="list-style-type: none"> Prepara a achment of Back Pocket 	AMH/N0301	<ul style="list-style-type: none"> ching Procedure Demonstra Ask the learner to think about sewing defects that can arise 	Fabric ,Pencil, Pen, sewing machine, thread, needle, bobbin, bobbin case, P t Handbook/ Facilitator Guide	6:00 hrs.
			<p>Practical</p> <ul style="list-style-type: none"> Prepara wing of Trouser Fly with Zipper 	AMH/N0301	<ul style="list-style-type: none"> ching Procedure Demonstra Ask the learner to think about sewing defects that can arise 	Fabric ,Pencil, Pen, sewing machine, thread, needle, bobbin, bobbin case, P t Handbook/ Facilitator Guide	6:00 hrs.
			<p>Practical</p> <ul style="list-style-type: none"> Waistband Prepara and a achment Belt loop making and a achment om Hemming 	AMH/N0301	<ul style="list-style-type: none"> ching Procedure Demonstra Ask the learner to think about sewing defects that can arise 	Fabric ,Pencil, Pen, sewing machine, thread, needle, bobbin, bobbin case, P t Handbook/ Facilitator Guide	2:00 hrs.
		ching a Shirt	<p>Theory</p> <ol style="list-style-type: none"> Familiarize with Shirt Components in a Shirt 	AMH/N0301	<ul style="list-style-type: none"> Power-point presenta Facilitator-led - discussion Audio-visualsImages 	Available Objects such as a book, pen, duster, white board, marker, Computer, Projector, etc.	2:00 hrs.
			<p>Theory</p> <ol style="list-style-type: none"> Seams in a Shirt Fits of a Shirt Trims used in Shirt 	AMH/N0301	<ul style="list-style-type: none"> Trainer Led Discussion 	PPT, Handbook, Pen , Pencil, Shirt	3:00 hrs.

			<p>Theory</p> <p>1. Types of Plackets, Pockets, etc</p>	AMH/N0301	<ul style="list-style-type: none"> Trainer Led Discussion 	PPT, Handbook, Pen , Pencil, Shirt	2:00 hrs.
			<p>Theory</p> <p>1. How is a Shirt Sewn (Sewing Sequence)</p>	AMH/N0301	<ul style="list-style-type: none"> Trainer Led Discussion 	PPT, Handbook, Pen , Pencil, Shirt	3:00 hrs.
			<p>Practical</p> <ul style="list-style-type: none"> Placket on a Shirt 	AMH/N0301	<ul style="list-style-type: none"> Sewing Procedure Demonstration Ask the learner to think about sewing defects that can arise 	Fabric ,Pencil, Pen, sewing machine, thread, needle, bobbin, bobbin case, Pencil Handbook/ Facilitator Guide	4:00 hrs.
			<p>Practical</p> <ul style="list-style-type: none"> Pocket on a Shirt (different shapes) 	AMH/N0301	<ul style="list-style-type: none"> Sewing Procedure Demonstration Ask the learner to think about sewing defects that can arise 	Fabric ,Pencil, Pen, sewing machine, thread, needle, bobbin, bobbin case, Pencil Handbook/ Facilitator Guide	4:00 hrs.
			<p>Practical</p> <ul style="list-style-type: none"> Preparation of Sleeve Placket 	AMH/N0301	<ul style="list-style-type: none"> Sewing Procedure Demonstration Ask the learner to think about sewing defects that can arise 	Fabric ,Pencil, Pen, sewing machine, thread, needle, bobbin, bobbin case, Pencil Handbook/ Facilitator Guide	6:00 hrs.
			<p>Practical</p> <ul style="list-style-type: none"> Attaching Sleeve to a Shirt Sewing Yoke, Front & Back of Shirt 	AMH/N0301	<ul style="list-style-type: none"> Sewing Procedure Demonstration Ask the learner to think about sewing defects that can arise 	Fabric ,Pencil, Pen, sewing machine, thread, needle, bobbin, bobbin case, Pencil Handbook/ Facilitator Guide	6:00 hrs.
			<p>Practical</p> <ul style="list-style-type: none"> Preparation of Collar Band and its attachment to the Shirt 	AMH/N0301	<ul style="list-style-type: none"> Sewing Procedure Demonstration Ask the learner to think about sewing defects that can arise 	Fabric ,Pencil, Pen, sewing machine, thread, needle, bobbin, bobbin case, Pencil Handbook/ Facilitator Guide	6:00 hrs.
			<p>Practical</p> <ul style="list-style-type: none"> Preparation of different shaped Collars 	AMH/N0301	<ul style="list-style-type: none"> Sewing Procedure Demonstration Ask the learner to think about sewing defects that can arise 	Fabric ,Pencil, Pen, sewing machine, thread, needle, bobbin, bobbin case, Pencil Handbook/ Facilitator Guide	4:00 hrs.
			<p>Practical</p> <ul style="list-style-type: none"> Assembling all garment components together (Shirt/ Trouser) 	AMH/N0301	<ul style="list-style-type: none"> Sewing Procedure Demonstration Ask the learner to think about sewing defects that can arise 	Fabric ,Pencil, Pen, sewing machine, thread, needle, bobbin, bobbin case, Pencil Handbook/ Facilitator Guide	4:00 hrs.

			<ul style="list-style-type: none"> Ensure learning con 	AMH/N0301	<ul style="list-style-type: none"> Facilitator led ques wer session Gauge the learner for their understanding & pr module Process based gauging to map learning curve 	Notepad, Fabric ,Pencil, Pen, sewing machine, thread, needle, bobbin, bobbin case, P t Handbook/ Facilitator Guide	
3.	Contribute to achieve product quality in s ching opera	Contribute to achieve product quality in s ching opera	<p>Theory</p> <ol style="list-style-type: none"> Create an understanding of Product Quality and guidelines provided 	AMH/N0302	<ul style="list-style-type: none"> Power-point presenta Facilitator-led - discussion Audio-visuals Clips 	Available Objects such as a book, pen, duster, white board, marker, Computer, Projector, etc.	2:00 hrs.
			<p>Theory</p> <ol style="list-style-type: none"> Understanding of Sewing Pr w 	AMH/N0302	<ul style="list-style-type: none"> Power-point presenta Facilitator-led - discussion Audio-visuals Clips 	Available Objects such as a book, pen, duster, white board, marker, Computer, Projector, etc.	2:00 hrs.
			<p>Theory</p> <ol style="list-style-type: none"> Expected quality in s ching 	AMH/N0302	<ul style="list-style-type: none"> Power-point presenta Facilitator-led - discussion Audio-visuals Clips 	Available Objects such as a book, pen, duster, white board, marker, Computer, Projector, etc.	2:00 hrs.
			<p>Theory</p> <ol style="list-style-type: none"> Importance of having e e communica 	AMH/N0302	<ul style="list-style-type: none"> Power-point presenta Facilitator-led - discussion Audio-visuals Clips 	Available Objects such as a book, pen, duster, white board, marker, Computer, Projector, etc.	2:00 hrs.
			<p>Pr al</p> <ul style="list-style-type: none"> Demonstra wing pr w and its importance 	AMH/N0302	<ul style="list-style-type: none"> Pr al Lab 	Note Pad, Pen, charts	4:00 hrs.
			<p>Theory</p> <ol style="list-style-type: none"> Frequently occurring defects ched products against a 	AMH/N0302	<ul style="list-style-type: none"> Power-point presenta Facilitator-led - discussion Audio-visuals Images 	Available Objects such as a book, pen, duster, white board, marker, Computer, Projector, etc.	2:00 hrs.
			<p>Theory</p> <ol style="list-style-type: none"> Familiarize with the quality department and its role in pr Learn about the fabric defects 	AMH/N0302	<ul style="list-style-type: none"> Power-point presenta Facilitator-led - discussion Audio-visuals Images 	Available Objects such as a book, pen, duster, white board, marker, Computer, Projector, etc.	2:00 hrs.
			<p>Theory</p> <ol style="list-style-type: none"> Learn about common woven & knit fabric defects Learn about accessories defect 	AMH/N0302	<ul style="list-style-type: none"> Power-point presenta Facilitator-led - discussion Audio-visuals Images 	Available Objects such as a book, pen, duster, white board, marker, Computer, Projector, etc.	1:00 hrs.
			<p>Theory</p> <ol style="list-style-type: none"> Learn about s ch & Seam defects 	AMH/N0302	<ul style="list-style-type: none"> Power-point presenta Facilitator-led - discussion Audio-visuals Clips 	Available Objects such as a book, pen, duster, white board, marker, Computer, Projector, etc.	2:00 hrs.
			<p>Pr al</p> <ul style="list-style-type: none"> R ys ch & seam defects 	AMH/N0302	<ul style="list-style-type: none"> Pr al Lab 	Note Pad, Pen, charts	3:00 hrs.

			<p>Practical</p> <ul style="list-style-type: none"> Identify and perform alterations 	AMH/N0302	<ul style="list-style-type: none"> Use previously scheduled components 	Pre-sewed components, Pencil, Pen, sewing machine, thread, needle, bobbin, bobbin case, Pattern Handbook/ Facilitator Guide	3:00 hrs.
			<p>Practical</p> <ul style="list-style-type: none"> Pressing in straight lines to achieve desired quality & speed 	AMH/N0302	<ul style="list-style-type: none"> Facilitator led Pr 	Fabric, Pencil, Pen, sewing machine, thread, needle, bobbin, bobbin case, Pattern Handbook/ Facilitator Guide	7:00 hrs.
			<p>Practical</p> <ul style="list-style-type: none"> Pressing in curved lines to achieve desired quality & speed 	AMH/N0302	<ul style="list-style-type: none"> Facilitator led Pr 	Fabric, Pencil, Pen, sewing machine, thread, needle, bobbin, bobbin case, Pattern Handbook/ Facilitator Guide	8:00 hrs.
			<p>Practical</p> <ul style="list-style-type: none"> Pressing seams to achieve desired quality & speed 	AMH/N0302	<ul style="list-style-type: none"> Facilitator led Pr 	Fabric, Pencil, Pen, sewing machine, thread, needle, bobbin, bobbin case, Pattern Handbook/ Facilitator Guide	8:00 hrs.
			<p>Practical</p> <ul style="list-style-type: none"> Pressing Collared Shirt Components to achieve desired quality & speed 	AMH/N0302	<ul style="list-style-type: none"> Facilitator led Pr 	Fabric, Pencil, Pen, sewing machine, thread, needle, bobbin, bobbin case, Pattern Handbook/ Facilitator Guide	6:00 hrs.
			<p>Practical</p> <ul style="list-style-type: none"> Pressing on Collared Trouser Components to achieve desired quality & speed 	AMH/N0302	<ul style="list-style-type: none"> Facilitator led Pr 	Fabric, Pencil, Pen, sewing machine, thread, needle, bobbin, bobbin case, Pattern Handbook/ Facilitator Guide	6:00 hrs.
			<ul style="list-style-type: none"> Ensure learning conclusion 	AMH/N0302	<ul style="list-style-type: none"> Facilitator led ques wer session Gauge the learner for their understanding & performance Process based gauging to map learning curve 	Notepad, Fabric, Pencil, Pen, sewing machine, thread, needle, bobbin, bobbin case, Pattern Handbook/ Facilitator Guide	
4.	Maintain Work Area, Tools and Machines	Maintain Work Area, Tools and Machines	<p>Theory</p> <ol style="list-style-type: none"> Importance of machine cleanliness and maintenance 	AMH/N0102	<ul style="list-style-type: none"> Facilitator-led - discussion 	Handbook/ Facilitator Guide	3:00 hrs.

			<p>Theory</p> <p>1. Importance of Prevention & Running maintenance of machine & tools</p>	AMH/N0102	<ul style="list-style-type: none"> Facilitator-led - discussion 	Handbook/ Facilitator Guide	3:00 hrs.
			<p>Theory</p> <p>1. Minimize waste 2. Safe waste disposal in the designated location</p>	AMH/N0102	<ul style="list-style-type: none"> Facilitator-led - discussion 	Handbook/ Facilitator Guide	2:00 hrs
			<p>Theory</p> <p>1. Work in a comfortable posture and maintain personal health safety measures</p>	AMH/N0102	<ul style="list-style-type: none"> Facilitator-led - discussion 	Handbook/ Facilitator Guide	2:00 hrs.
			<p>Practical</p> <ul style="list-style-type: none"> Steps of cleaning the bobbin area Steps of cleaning the tension assembly Cleaning the feed dog assembly 	AMH/N0102	<ul style="list-style-type: none"> Practical Lab 	Note Pad, Pen, sewing machine	4:00 hrs.
			<p>Practical</p> <ul style="list-style-type: none"> Change needle guard Maintain machine after work is done 	AMH/N0102	<ul style="list-style-type: none"> Practical Lab 	Note Pad, Pen, sewing machine	4:00 hrs.
			<p>Practical</p> <ul style="list-style-type: none"> Maintain machine after work is done 	AMH/N0102	<ul style="list-style-type: none"> Practical Lab 	Note Pad, Pen, sewing machine	4:00 hrs.
			<p>Practical</p> <ul style="list-style-type: none"> Steps in lubricating Machine 	AMH/N0102	<ul style="list-style-type: none"> Practical Lab 	Note Pad, Pen, sewing machine, Oil	4:00 hrs.
			<p>Practical</p> <ul style="list-style-type: none"> Machine guards Sewing machine safety signs 	AMH/N0102	<ul style="list-style-type: none"> Practical Lab 	Note Pad, Pen, sewing machine	4:00 hrs.
			<ul style="list-style-type: none"> Ensure learning conditions 	AMH/N0102	<ul style="list-style-type: none"> Facilitator led question session Gauge the learner for their understanding & prepare module Process based gauging to map learning curve 	Notepad, Fabric, Pencil, Pen, sewing machine, thread, needle, bobbin, bobbin case, Projector Handbook/ Facilitator Guide	
5.	Maintaining Health, Safety and Security at Workplace	Maintaining Health, Safety and Security at Workplace	<p>Theory</p> <p>1. Health & Safety related incidents at the workplace</p>	AMH/N0103	<ul style="list-style-type: none"> Facilitator-led - discussion 	Charts of good personal health practices, note pad, pen, audio-visual clips	1:00 hrs.
			<p>Theory</p> <p>1. Identification of Personal Protective Equipment</p>	AMH/N0103	<ul style="list-style-type: none"> Facilitator-led - discussion 	Chart for PPE, note pad, pen, audio-visual clips	1:00 hrs.
			<p>Theory</p> <p>1. Probable hazards at the workplace and handling them</p>	AMH/N0103	<ul style="list-style-type: none"> Facilitator-led - discussion 	Note pad, pen, Computer, Projector audio-visual clips	2:00 hrs.
			<p>Theory</p> <p>1. Probable machine/equipment</p>	AMH/N0103	<ul style="list-style-type: none"> Facilitator-led - discussion 	Note pad, pen, Computer, Projector audio	2:00 hrs.
			<p>Theory</p> <p>1. First Aid & its application</p>	AMH/N0103	<ul style="list-style-type: none"> Facilitator-led - discussion 	Chart for First Aid materials, pen, Computer, Projector audio, First Aid Box	2:00 hrs.

			<p>Practical</p> <ul style="list-style-type: none"> Wearing and using PPE 	AMH/N0103	<ul style="list-style-type: none"> Practical Lab 	Note Pad, Pen, Various PPEs	2:00 hrs.
			<p>Practical</p> <ul style="list-style-type: none"> Mock Drills / Evacuation Use of First Aid 	AMH/N0103	<ul style="list-style-type: none"> Practical Lab 	Note Pad, Pen	8:00 hrs.
			<p>Practical</p> <ul style="list-style-type: none"> Periodic walkthrough for hazard identification 	AMH/N0103	<ul style="list-style-type: none"> Practical Lab 	Note Pad, Pen	2:00 hrs.
			<p>Practical</p> <ul style="list-style-type: none"> Emergency Preparedness & Response Safety Signs at workplace 	AMH/N0103	<ul style="list-style-type: none"> Practical Lab 	Note Pad, Pen	6:00 hrs.
			<ul style="list-style-type: none"> Ensure learning completion 	AMH/N0103	<ul style="list-style-type: none"> Facilitator led question session Gauge the learner for their understanding & performance module Process based gauging to map learning curve 	Notepad, Fabric, Pencil, Pen, sewing machine, thread, needle, bobbin, bobbin case, Pattern Handbook/ Facilitator Guide	
6.	Comply with Industry, Regulatory and Organizational Requirements	Comply with Industry, Regulatory and Organizational Requirements	<p>Theory</p> <ol style="list-style-type: none"> General policies and regulations of the Industry Providing support to supervisors and team members 	AMH/N0104	<ul style="list-style-type: none"> Power-point presentation Facilitator-led – discussion Audio-visuals Clips 	Available Objects such as a book, pen, duster, white board, marker, Computer, Projector, etc.	3:00 hrs.
			<p>Practical</p> <ul style="list-style-type: none"> Identify policy deviations Working in a team 	AMH/N0104	<ul style="list-style-type: none"> Role Plays/team Work 	Note Pad, Pen	3:00 hrs.
			<p>Practical</p> <ul style="list-style-type: none"> Role of APEC in Indian Garment Industry Importance of compliance in Indian Garment Industry 	AMH/N0104	<ul style="list-style-type: none"> Facilitator-led – discussion 	Note Pad, Pen	2:00 hrs.
			<ul style="list-style-type: none"> Ensure learning completion 	AMH/N0104	<ul style="list-style-type: none"> Facilitator led question session Gauge the learner for their understanding & performance module Process based gauging to map learning curve 	Notepad, Fabric, Pencil, Pen, sewing machine, thread, needle, bobbin, bobbin case, Pattern Handbook/ Facilitator Guide	
7.	Professional Skills	Professional Skills	<p>Theory</p> <ol style="list-style-type: none"> Oriented towards managing job related stress effectively Create an understanding about work ethics 	Bridge Module	<ul style="list-style-type: none"> Power-point presentation Facilitator-led - discussion Audio-visuals Clips 	Presentation Audi-visual clips, Pattern Handbooks, Note Pad, Pen	2:00 hrs.
			<p>Theory</p> <ol style="list-style-type: none"> Awareness towards AIDS Importance of health and hygiene Awareness about ill effects of alcohol and tobacco. 	Bridge Module	<ul style="list-style-type: none"> Power-point presentation Facilitator-led - discussion Audio-visuals Clips 	Presentation Audi-visual clips, Pattern Handbooks, Note Pad, Pen	2:00 hrs.
			<p>Practical</p> <ul style="list-style-type: none"> Create resume 	Bridge Module	<ul style="list-style-type: none"> Facilitator-led - discussion 	Note Pad, Pen	2:00 hrs.

			<ul style="list-style-type: none"> Ensure learning con 	Bridge Module	<ul style="list-style-type: none"> Facilitator led ques wer session Gauge the learner for their understanding & pr module Process based gauging to map learning curve 	Notepad, Fabric, Pencil, Pen, sewing machine, thread, needle, bobbin, bobbin case, P t Handbook/ Facilitator Guide	
8.	IT Skills	Intr o Computer	<p>Theory</p> <ol style="list-style-type: none"> Computer & Computer Peripherals The advantages and disadvantages of computer 	Digital Literacy	<ul style="list-style-type: none"> Power-point presenta Facilitator-led - discussion Audio-visuals Clips 	Available Objects such as P t Handbook / Facilitator's Guide, pen, duster, white board, marker, Computer, Projector etc.	
		Basic Computer Knowledge	<p>Theory</p> <ol style="list-style-type: none"> Orient towards how to perform simple tasks using computer 	Digital Literacy	<ul style="list-style-type: none"> Power-point presenta Facilitator-led - discussion Audio-visuals Clips 	Available Objects such as P t Handbook / Facilitator's Guide, pen, duster, white board, marker, Computer, Projector etc.	
		Components of Computer	<p>Theory</p> <ol style="list-style-type: none"> Know erent parts and components of computer 	Digital Literacy	<ul style="list-style-type: none"> Power-point presenta Facilitator-led - discussion Audio-visuals Clips 	Available Objects such as P t Handbook / Facilitator's Guide, pen, duster, white board, marker, Computer, Projector etc.	
		Concept of Opera ystem	<p>Theory</p> <ol style="list-style-type: none"> Familiarise with opera windows and doing simple tasks 	Digital Literacy	<ul style="list-style-type: none"> Power-point presenta Facilitator-led - discussion Audio-visuals Clips 	Available Objects such as P t Handbook / Facilitator's Guide, pen, duster, white board, marker, Computer, Projector etc.	
		MS Word	<p>Theory</p> <ol style="list-style-type: none"> Familiarise towards making and prin document 	Digital Literacy	<ul style="list-style-type: none"> Power-point presenta Facilitator-led - discussion Audio-visuals Clips 	Available Objects such as P t Handbook / Facilitator's Guide, pen, duster, white board, marker, Computer, Projector etc.	

		MS Power Point	<p>Theory</p> <ol style="list-style-type: none"> Orient towards form a slide and making a presenta – Powerpoint. 	Digital Literacy	<ul style="list-style-type: none"> Power-point presenta Facilitator-led – discussion Audio-visuals Clips 	Available Objects such as P t Handbook / Facilitator’s Guide, pen, duster, white board, marker, Computer, Projector, etc.	
		MS Excel	<p>Theory</p> <ol style="list-style-type: none"> Orient towards form cell contents and other features in MS-Excel 	Digital Literacy	<ul style="list-style-type: none"> Power-point presenta Facilitator-led – discussion Audio-visuals Clips 	Available Objects such as P t Handbook / Facilitator’s Guide, pen, duster, white board, marker, Computer, Projector, etc.	
		Internet Concepts	<p>Theory</p> <ol style="list-style-type: none"> Orient towards using the internet to gather informa 	Digital Literacy	<ul style="list-style-type: none"> Power-point presenta Facilitator-led – discussion Audio-visuals Clips 	Available Objects such as P t Handbook / Facilitator’s Guide, pen, duster, white board, marker, Computer, Projector, etc.	
			<ul style="list-style-type: none"> Ensure learning con 	Digital Literacy	<ul style="list-style-type: none"> Facilitator led ques wer session Gauge the learner for their understanding & pr module Process based gauging to map learning curve 	Notepad, Fabric ,Pencil, Pen, sewing machine, thread, needle, bobbin, bobbin case, P t Handbook/ Facilitator Guide	
9.	Employability and Entrepreneurship skills	Personal Strengths & Value Systems	<p>Theory</p> <ol style="list-style-type: none"> Awareness towards maintain health & hygiene Familiarise with life skills Self analysis & self a Stress & Anger Management ful Entrepreneur workplace Work ethics 	Bridge Module	<ul style="list-style-type: none"> Power-point presenta Facilitator-led – discussion Audio-visuals Clips 	Available Objects such as P t Handbook / Facilitator’s Guide, pen, duster, white board, marker, Computer, Projector, etc.	
		Digital Literacy: A Recap	<p>Theory</p> <ol style="list-style-type: none"> Basic parts of computer & computer peripherals Basic computer terminology Basic computer applica Outlook, Internet) Basic features of using e-commerce 	Bridge Module	<ul style="list-style-type: none"> Power-point presenta Facilitator-led – discussion Audio-visuals Clips 	Available Objects such as P t Handbook / Facilitator’s Guide, pen, duster, white board, marker, Computer, Projector, etc.	

		Money Ma ers	<p>Theory</p> <ol style="list-style-type: none"> 1. Opening and opera bank account 2. Importance and methods of savings 3. Investment op 4. Insurance products 5. Cost of Opera 6. Types of Fund Transfer 	Bridge Module	<ul style="list-style-type: none"> • Power-point presenta • Facilitator-led – discussion • Audio-visuals Clips 	Available Objects such as P t Handbook / Facilitator's Guide, pen, duster, white board, marker, Computer, Projector, etc.	
		Preparing for Employment and Self Employment	<p>Theory</p> <ol style="list-style-type: none"> 1. Discuss the steps to prepare for an interview 2. Discuss the steps to create an e e Resume 3. Discuss the most frequently asked interview ques 4. Discuss how to answer the most frequently asked interview ques 5. Discuss basic workplace terminology 	Bridge Module	<ul style="list-style-type: none"> • Power-point presenta • Facilitator-led – discussion • Audio-visuals Clips 	Available Objects such as P t Handbook / Facilitator's Guide, pen, duster, white board, marker, Computer, Projector, etc.	
		Understanding Entrepreneurship	<p>Theory</p> <ol style="list-style-type: none"> 1. Discuss the concept ad characteris entrepreneurship 2. erent types of enterprises 3. Establishing e e leadership 4. Team Work 5. Importance of e e communica 6. Discuss about Neg Skills and Con R 7. Entrepreneurship ecosystem in India 	Bridge Module	<ul style="list-style-type: none"> • Power-point presenta • Facilitator-led – discussion • Audio-visuals Clips 	Available Objects such as P t Handbook / Facilitator's Guide, pen, duster, white board, marker, Computer, Projector, etc.	
		Preparing to be an Entrepreneur	<p>Theory</p> <ol style="list-style-type: none"> 1. Basic Marke 2. Recall basic business terminology 3. CRM and its importance 4. Se ving goals 5. Making a Business Plan 6. Carrying out a market research 7. CRM and its importance 8. Business & Financial Planning Process 9. Managing a enterprise 	Bridge Module	<ul style="list-style-type: none"> • Power-point presenta • Facilitator-led – discussion • Audio-visuals Clips 	Available Objects such as P t Handbook / Facilitator's Guide, pen, duster, white board, marker, Computer, Projector, etc.	
			<ul style="list-style-type: none"> • Ensure learning con 	Bridge Module	<ul style="list-style-type: none"> • Facilitator led ques wer session • Gauge the learner for their understanding & pr module • Process based gauging to map learning curve 	Notepad, Fabric ,Pencil, Pen, sewing machine, thread, needle, bobbin, bobbin case, P t Handbook/ Facilitator Guide	

Annexure II

Assessment Criteria

CRITERIA FOR ASSESSMENT OF TRAINEES

Assessment Criteria for Hand Embroiderer	
Job Role	Sewing Machine Operator
Package	AMH/Q0301
Sector Skill Council	APPAREL, MADE-UP'S AND HOME FURNISHING
Sr. No.	Guidelines for Assessment
1	Criteria for assessment for each Package will be created by the Sector Skill Council. Each Performance Criteria (PC) will be assigned mark
2	Each NOS will assessed both for theoretical knowledge and practical
3	The assessment will be based on knowledge bank of questions created by the SSC.
4	Individual assessment agencies will create unique question papers for theory and skill practical part for each candidate at each examination center
5	Throughout the package, every trainee should score a minimum of 70% in every NOS
6	In case of successfully passing only certain number of NOS's, the trainee is eligible to take subsequent assessment on the balance NOS's throughout the package.

		Marks Allocation				
		Total Marks 400	Out Of	Theory	Skills Practical	Viva
1. AMH/N0301 (Carryout Stitching activities using machine or by hand)	PC1. Make sure the work area is free from hazards	210	3	1	1	1
	PC2. Follow the instructions on the work ticket/ job card in line with the responsibilities of respective job role		3	1	1	1
	PC3. Ask questions to obtain more information on tasks when the instructions you have are unclear		3	1	1	1
	PC4. Agree and review your agreed upon work targets with your supervisor and check for special instructions, if any		3	1	1	1
	PC5. Use the correct tools and equipments		3	1	1	1

	PC6. Check that equipment is safe and set up in readiness for use		3	1	1	1
	PC7. Select the correct component parts for the style being worked on		3	1	1	1
	PC8. Check that the materials to be used are free from faults		5	1	3	1
	PC9. Ensure the materials used meet the specification matching		3	1	1	1
	a. Within a product		4	1	2	1
	b. Between a pair of products where applicable		4	1	2	1
	PC10. Carry out test sews		4	1	2	1
	PC11. Check needles, awls and threads regularly		4	1	2	1
	PC12. Check if fabric / Component is correctly marked and pieces cut as required		4	1	2	1
	PC13. Fabric pieces and linings are pinned or sewn together as required, and appropriately hung in readiness for assembly		4	1	2	1
	PC14. Report faults in the materials		3	1	1	1
	PC15. Conform to company quality standards		3	1	1	1
	PC16. Report any damaged work to the responsible person		3	1	1	1
	PC17. Follow company reporting procedures about defective tools and machines which affect work and report risks/ problems likely to affect services to the relevant person promptly and accurately		4	1	2	1
	PC18. Sort and place work to assist the next stage of production and minimise the risk of damage		3	1	1	1
	PC19. Leave work area safe and secure when work is complete		4	1	2	1
	PC20. Complete forms, records and other documentation		4	2	1	1
	PC21. Examine the specific item to identify what type of stitching is best suited		4	1	2	1
	PC22. Estimate the expected length of time for the process		4	1	1	2

PC23. Set up machine (Apparel Sewing machine) according to manufacturers' instructions and production requirements	4	1	2	1
PC24. Set machine controls for the materials being stitched	5	1	3	1
PC25. Cut the thread appropriately	4	1	2	1
PC26. Thread the needle in the machine and adjust the needle as per the requirements	4	1	2	1
PC27. Perform a test run to ensure machine is operating correctly	4	1	2	1
PC28. Report defective machines, tools and/or equipment to the responsible person	4	1	2	1
PC29. Operate machines safely and in accordance with guidelines	5	1	3	1
PC30. Optimize the positioning and layout of materials to ensure a smooth and rapid throughput	6	1	4	1
PC31. Check the equipment prior to making the stitching, including:	3	1	1	1
a) Correct controls	4	1	2	1
b) Correct attachments	4	1	2	1
c) Changing needles	4	1	2	1
d) Changing threads	4	1	2	1
e) Changing awls	4	1	2	1
f) Correct Timing	4	1	2	1
PC32. Stitch the correct materials in the right sequence as required by the production specification	6	1	4	1
PC33. Ensure stitched product conforms to shape and size requirement	4	1	2	1
PC34. Ensure stitched products meets specification in terms of labels and trimmings	4	1	2	1
PC35. Inspect stitched products against specifications	4	1	2	1
PC36. Identify mark and place rejects in the designated locations	4	1	2	1

	PC37. Carry out alterations to meet customer requirements		4	1	2	1
	PC38. Pass the stitched item to the next stage in the manufacturing process after validation		4	1	2	1
	PC39. Respond accordingly where stitched items do not meet production specification		4	1	2	1
	PC40. Minimize and dispose the waste materials in the approved manner		4	1	2	1
	PC41. Seek feedback from team mates on work related performance		3	1	1	1
	PC42. Check with in charge /others when unsure of new product details		4	1	2	1
	PC43. Clean and make safe machines after use		5	1	3	1
	PC44. Carry out basic maintenance of own machines		4	1	2	1
	PC45. Report risks/ problems likely to affect services to the relevant person promptly and accurately		4	1	2	1
	PC46. Carry out Operations at a rate which maintains workflow and meets production targets		4	1	2	1
		Total	210	55	100	55
2. AMH/N0302 (Contribute to achieve product quality in stitching operations)						
	PC1. Identify and use materials required based on the job card/ work ticket		4	2	1	1
	PC2. Take the necessary action when materials do not conform to company quality standards	65	4	1	2	1
	PC3. Report and replace identified faulty materials and component parts which do not meet specification		4	1	2	1
	PC4. Identify modifiable defects and rework on them		5	1	3	1
	PC5. Carry out work safely and at a rate which maintains work flow		4	1	2	1

	PC6. Report to the responsible person when the work flow of other production areas disrupts work		4	1	2	1
	PC7. Test, sort, track feed and examine work in progress		5	1	3	1
	PC8. Carry out quality checks at specified intervals according to instructions		5	1	3	1
	PC9. Apply the allowed tolerances		4	1	2	1
	PC10. Identify faults and take appropriate action for rectification		5	1	3	1
	PC11. Make adjustments promptly to return product to specification		4	1	2	1
	PC12. Fault-find materials and components for creased, stained, damage and incorrectly made-up component parts		4	1	2	1
	PC13. Report faults in other processes to the appropriate person		4	1	2	1
	PC14. Maintain the required productivity and quality levels		5	1	3	1
	PC15. Complete and maintain documentation		4	1	2	1
		Total	65	16	34	15
3. AMH/N0102						
Maintain work area, tools and machines	PC1. Handle materials, machinery, equipment and tools safely and correctly		3	1	1	1
	PC2. Use correct lifting and handling procedures		3	1	1	1
	PC3. Use materials to minimize waste		3	1	1	1
	PC4. Maintain a clean and hazard free working area	50	4	1	2	1
	PC5. Maintain tools and equipment		4	1	2	1
	PC6. Carry out running maintenance within agreed schedules		4	1	2	1
	PC7. Carry out maintenance and/or cleaning within one's responsibility		4	1	2	1
	PC8. Report unsafe equipment and other dangerous occurrences		3	1	1	1
	PC9. Ensure that the correct machine guards are in place		3	1	1	1

	PC10. Work in a comfortable position with the correct posture		4	1	2	1
	PC11. Use cleaning equipment and methods appropriate for the work to be carried out		3	1	1	1
	PC12. Dispose of waste safely in the designated location		4	1	2	1
	PC13. Store cleaning equipment safely after use		4	1	2	1
	PC14. Carry out cleaning according to schedules and limits of responsibility		4	1	2	1
		Total	50	14	22	14
4. AMH/N0103 Maintain health, safety and security at workplace	PC1. Comply with health and safety related instructions applicable to the workplace	60	3	1	1	1
	PC2. Use and maintain personal protective equipment as per protocol		4	1	2	1
	PC3. Carry out own activities in line with approved guidelines and procedures		4	1	2	1
	PC4. Maintain a healthy lifestyle and guard against dependency on intoxicants		3	1	1	1
	PC5. Follow environment management system related procedures		3	1	1	1
	PC6. Identify and correct (if possible) malfunctions in machinery and equipment		4	1	2	1
	PC7. Report any service malfunctions that cannot be rectified		3	1	1	1
	PC8. Store materials and equipment in line with manufacturer's and organisational requirements		4	1	2	1
	PC9. Safely handle and move waste and debris		3	1	1	1
	PC10. Minimize health and safety risks to self and others due to own actions		3	1	1	1
	PC11. Seek clarifications, from supervisors or other authorized personnel in case of perceived risks		3	1	1	1

	PC12. Monitor the workplace and work processes for potential risks and threats		3	1	1	1
	PC13. Carry out periodic walk-through to keep work area free from hazards and obstructions, if assigned		3	1	1	1
	PC14. Report hazards and potential risks/ threats to supervisors or other authorized personnel		3	1	1	1
	PC15. Participate in mock drills/ evacuation procedures organized at the workplace		4	1.5	2	0.5
	PC16. Undertake first aid, fire-fighting and emergency response training, if asked to do so		4	1.5	2	0.5
	PC17. Take action based on instructions in the event of fire, emergencies or accidents		3	1.5	1	0.5
	PC18. Follow organization procedures for shutdown and evacuation when required		3	1.5	1	0.5
		Total	60	20	24	16
AMH/N0104 - Comply with industry, regulatory and organizational requirements	PC1. Carry out work functions in accordance with legislation and regulations, organizational guidelines and procedures	15	3	1	1	1
	PC2. Seek and obtain clarifications on policies and procedures, from your supervisor or other authorized personnel		3	1	1	1
	PC3. Apply and follow these policies and procedures within your work practices		3	1	1	1
	PC4. Provide support to your supervisor and team members in enforcing these considerations		3	1	1	1
	PC5. Identify and report any possible deviation to these requirements		3	1	1	1
		Total	15	5	5	5
Grand Total			400	110	185	105

Do 

- Explain each Guideline for Assessment in detail
- Explain the score that each trainee needs to obtain
- Recapitulate each NOS one-by-one and take through the allocation of marks for Theory and Skills Practical.
- Explain the Allocations. Explain that they will be assessed on Theory and Skills Practical.

Expository

(SHI) Speech and Hearing Impairment

MODULE	THEORY	PRACTICAL	TOTAL
	(hours)	(hours)	(hours)
Learn basic Indian Sign Language (ISL)	15	12	27
Use basic English	27	12	39
Personal and Social skills	9	3	12
Professional & Ethical behavior in the workplace	9	3	12
Keyboarding Skills	0	30	30
GRAND TOTAL	60	60	120

Learn Basic Indian Sign Language (ISL)

Terminal Outcomes:

- Communicate using basic Indian Sign Language.

Duration: 15:00	Duration: 12:00
Theory – Key Learning Outcomes	Practical – Key Learning Outcomes
<ul style="list-style-type: none"> • Discuss the regional differences in signs used in Indian Sign Language. • Describe ways to greet and respond to others. • Explain significance of facial expressions and gestures in enhancing meaning of signed words. • Discuss the general sentence rules used while signing 	<ul style="list-style-type: none"> • Demonstrate introductions and greetings using Indian Sign language • Demonstrate use of finger spellings in ISL (for example: names, places, and abbreviations.) • Express simple actions and feeling using ISL. • Express information related to time, directions, numbers, and currency using ISL. • Express information related to self-using ISL. (e.g., name, native place, city, state, family members, work etc.)

Classroom Aids

Laptop, white board, marker, projector

Tools, Equipment and Other Requirements

LCD TV, Visual curricula, Assistive Aid/Service, Ai-Live, Captions First, Captions 2020, Closed Capp, Let's Talk

Use Basic English

Terminal Outcomes:

- Apply knowledge of basic English to interpret information received and respond accordingly.
- Recognize familiar words and basic phrases concerning self, family members and immediate workplace.
- Read and write simple sentences in English about self, activities planned and events of the day.

Duration: 27:00	Duration: 12:00
Theory – Key Learning Outcomes	Practical – Key Learning Outcomes
<ul style="list-style-type: none"> • Recognize words and phrases related to formal and informal greetings. • Recognize simple personal information about self and others when shared in writing (e.g., name, age, place of residence etc.). • Recognize very simple words related to home, neighborhoods, everyday objects, market place, names of the days of the week, months, time, directions, clothes food and drinks. • Recognize simple pronouns (he/she/ we /they). • Comprehend basic hobby related verbs (like playing, singing, dancing). • Recognize common verbs related to movement of transport (e.g., buses run, boats sail). • Recognize words related to common feelings and emotions. (e.g., sad, unhappy, depressed, irritated, furious, angry). • Recognize familiar English words 	<ul style="list-style-type: none"> • Write basic personal information about self and others such as names, date of birth, ID numbers, address, nationality, marital status). • Use simple words related to common diseases in sentences (e.g., cold, cough, headache, fever, pain etc). • Write simple sentences using names of everyday objects, places, directions. (e.g., I live in Delhi.). • Write words related to professions. (like vacancy, sale, associate, manager, supervisor, file etc.). • Write words and short phrases to describe travel, holidays and vacations. • Frame written answer to simple questions related to self, food preferences, feelings etc. • Identify and read health, safety, security signage in English at works and public places or on gadgets and appliances when accompanied by related images or graphics. • Read basic familiar words and phrases to identify areas of work, responsibilities and working relationships.

and phrases used in the workplace especially as instructions related to direction, safety instructions, date, and time etc. (vocabulary: stop, close the door etc.).

- Read and write simple sentences describing activities planned for the next day/week/month etc.

Sample Classroom Aids

Laptop, white board, marker, projector

Tools, Equipment and Other Requirements

LCD TV, Visual curricula, Assistive Aid/Service, Ai-Live, Captions First, Captions 2020, Closed Capp, Let's Talk

Personal and Social Skill

Terminal Outcomes:

- Manage Professional and Social behavior.

Duration: 09:00	Duration: 03:00
Theory – Key Learning Outcomes	Practical – Key Learning Outcomes
<ul style="list-style-type: none"> • Discuss the importance of professional appearance and behavior at workplace. • Discuss the importance of following social etiquette in formal and informal settings. • Explain the principles of communication. • Discuss the barriers to effective communication and ways to overcome these. • Discuss the importance of managing stress. 	<ul style="list-style-type: none"> • Display professional appearance. • Demonstrate formal and informal communication etiquettes/gestures/body language in dealing with seniors/peers or clients. • Demonstrate ways to manage stress as per choice like breathing exercises/ spending time with friends etc. • Create a method for stress management with reference to self by listing techniques/steps.
Classroom Aids	
Laptop, white board, marker, projector	
Tools, Equipment and Other Requirements	
LCD TV, Visual curricula, Assistive Aid/Service, Ai-Live, Captions First, Captions 2020, Closed Capp, Let's Talk	

Professional & Ethical Behavior in the Workplace

Terminal Outcomes:

- Maintain professional and ethical behavior in the work environment.

Duration: 9:00	Duration: 03:00
Theory – Key Learning Outcomes	Practical – Key Learning Outcomes
<ul style="list-style-type: none"> • Discuss the importance of completing task/assignments on time/ by prioritizing. • Discuss the importance and challenges of teamwork in an organization to achieve goals. • Discuss the importance of seeking assistance from peers and supervisor when required. • Outline the importance of maintaining privacy and confidentiality. • Discuss situations that may lead to conflict of interest with peers/organization and ways to resolves them. 	<ul style="list-style-type: none"> • Prepare a work schedule prioritizing given tasks. • Demonstrate effective team behavior to accomplish a given task. • List activities/write application to seek assistance of supervisor/peers.
Classroom Aids	
Laptop, white board, marker, projector	
Tools, Equipment and Other Requirements	
LCD TV, Visual curricula, Assistive Aid/Service, Ai-Live, Captions First, Captions 2020, Closed Capp, Let's Talk	



Skill Council for Persons with Disability

Sector Skill Council Contact Details:

Address: 501, City Centre, Plot No. 5 Sector 12 Dwarka New Delhi - 110075

Website: www.scpwd.in

Phone: 01120892791

Price: ₹